

Relay <b>2</b>	Lane <b>1</b>	<b>Hans Christian Laubel</b>	
Day 3 Final		Gundsøllille Skytteforening	Mp
24.01.2021		GMO2021 Day 3	Gundsøllille OPEN 2021
1 Finaleserie		1: 9.5 ↙ 2: 9.9 ↙ 3: 7.5 → 4: 8.3 ↓ 5: 7.8 ↓	2 Finaleserie
		Series 43.0	1: 8.3 ↗ 2: 9.6 ↓ 3: 9.0 → 4: 10.5x ↗ 5: 8.8 ↘
		43.0	Series 46.2
			89.2
3 Finaleserie		1: 9.8 → 2: 8.5 ↑	4 Finaleserie
		Series 18.3	1: 9.7 ↓ 2: 9.8 ←
		107.5	Series 19.5
			127.0
5 Finaleserie		1: 9.2 ↓ 2: 10.4x ↘	
		Series 19.6	
		146.6	

Relay <b>2</b>	Lane <b>2</b>	<b>Kurt Witt</b>
-------------------	------------------	------------------

Day 3 Final	Ballerup skytteforening	Mp
-------------	-------------------------	----

24.01.2021	GMO2021 Day 3	Gundsøllille OPEN 2021
------------	---------------	------------------------

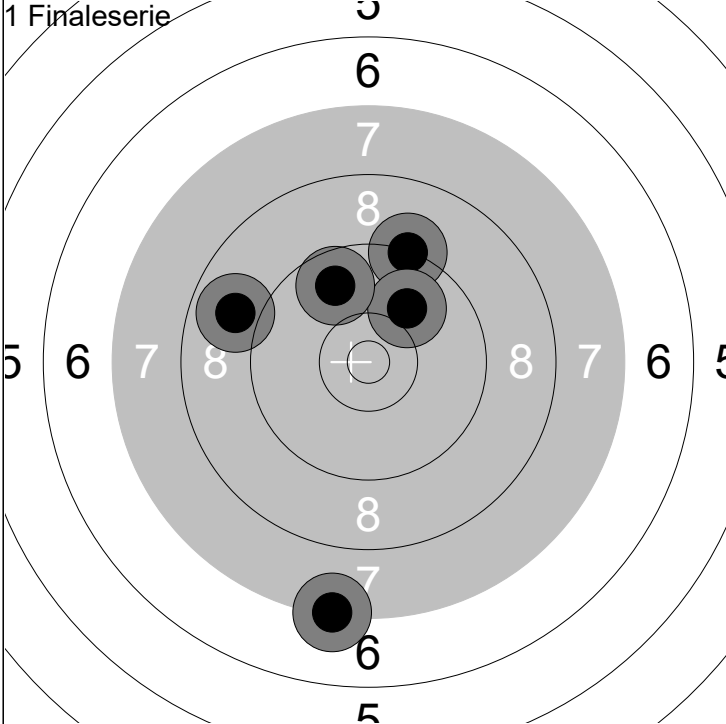

1:	8.9	↖
2:	9.3	↗
3:	10.0	↗
4:	9.7	↗
5:	7.3	↘

Series	45.2
	45.2

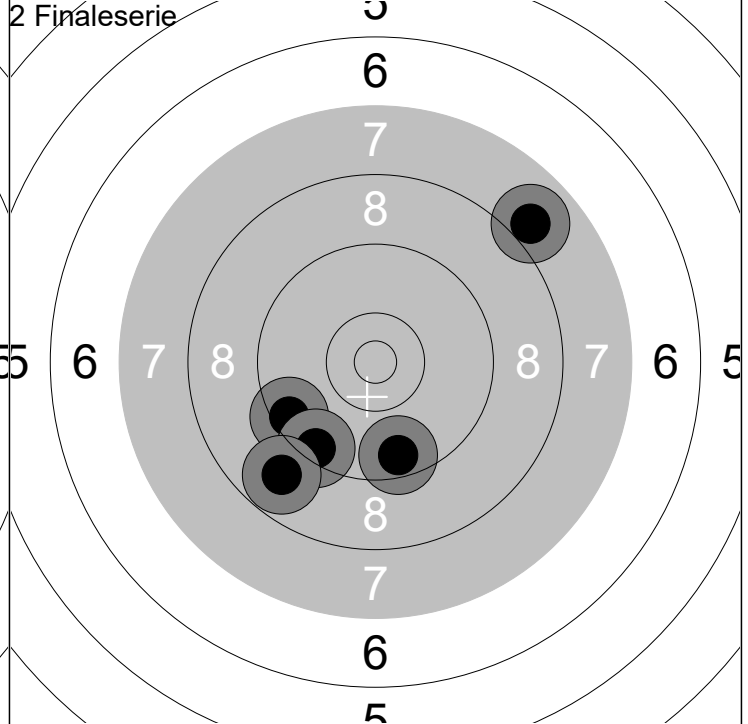

1:	7.9	↗
2:	9.5	↖
3:	9.6	↘
4:	9.4	↘
5:	8.8	↘

Series	45.2
	90.4

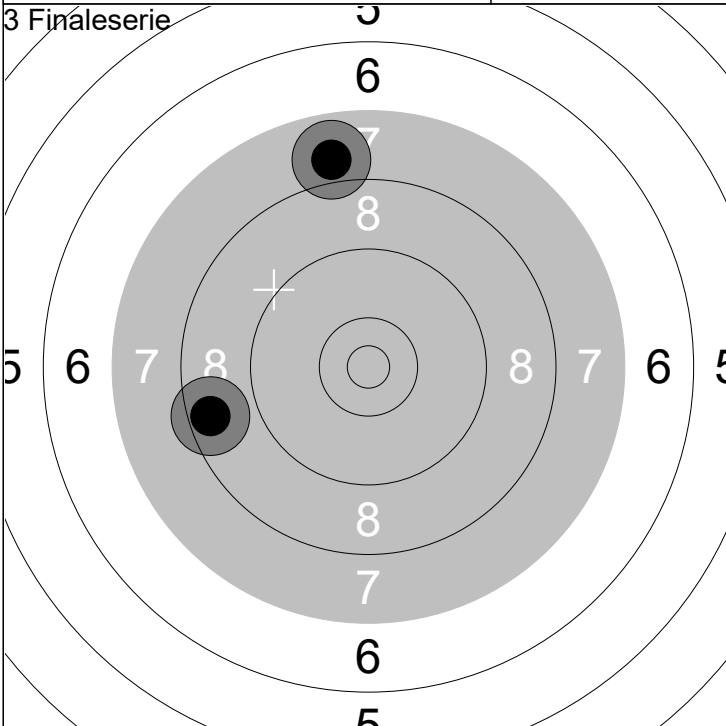

1:	8.5	↖
2:	7.9	↗

Series	16.4
	106.8

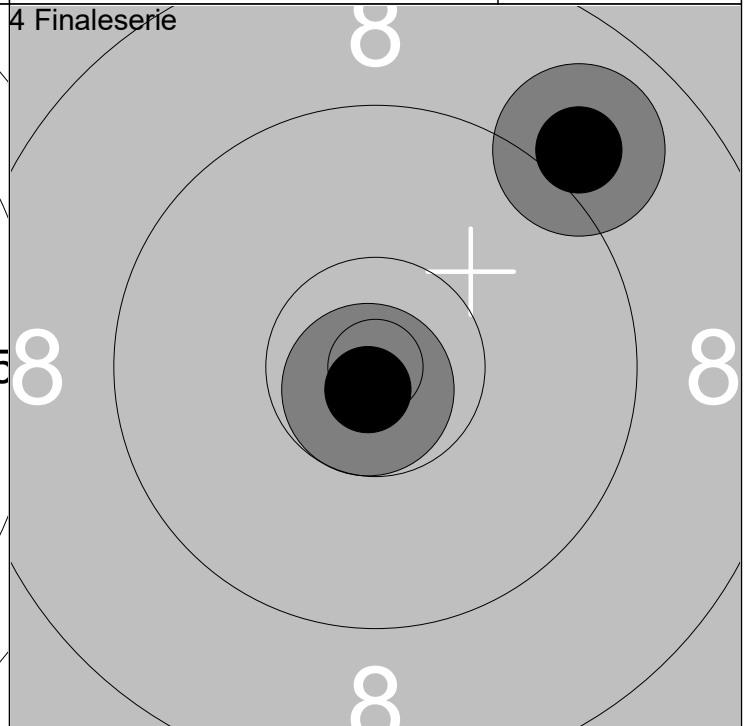

1:	10.8x	↘
2:	9.0	↗

Series	19.8
	126.6

Gundsøllille Megalink Open 2021

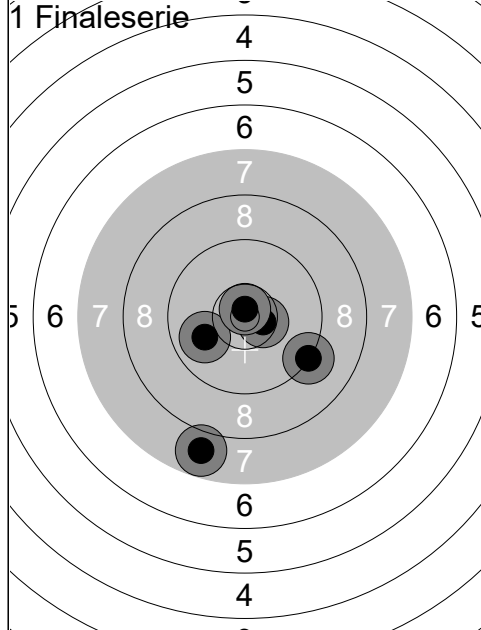

1:	9.9	↙
2:	7.8	↓
3:	10.5x	→
4:	10.8x	↑
5:	9.3	↘
<b>Series</b>		<b>48.3</b>
		48.3

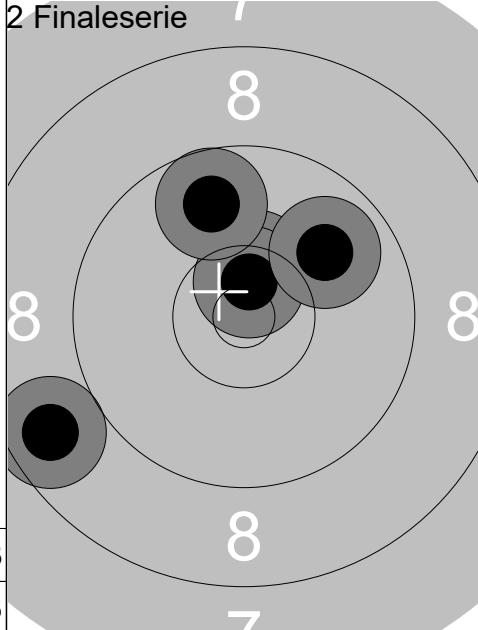

1:	10.4x	↑
2:	10.6x	↑
3:	8.7	↙
4:	9.9	↗
5:	9.8	↑
<b>Series</b>		<b>49.4</b>
		97.7

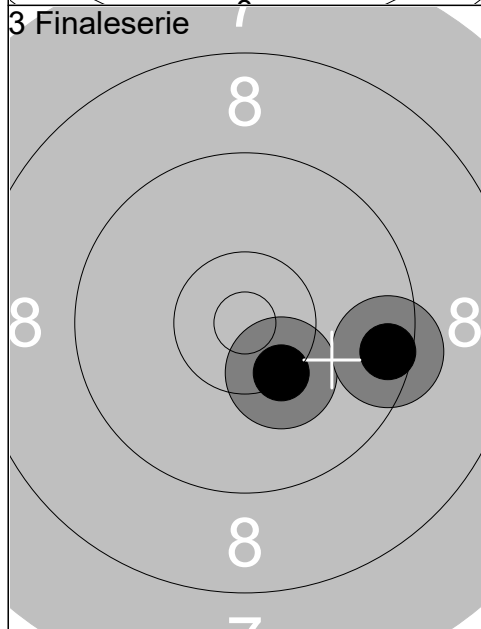

1:	10.3	↘
2:	9.5	→
<b>Series</b>		<b>19.8</b>
		117.5

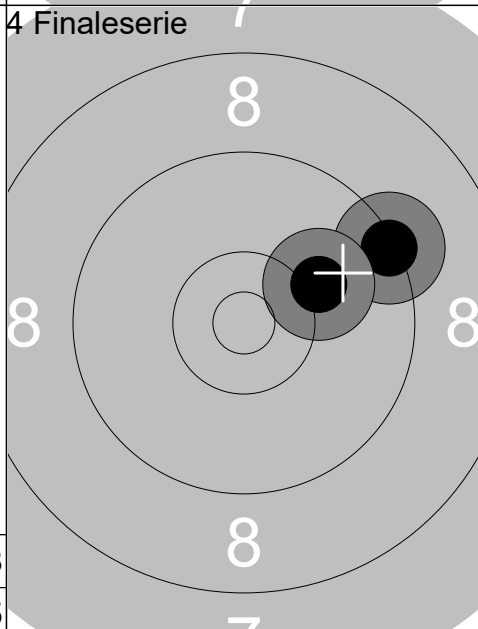

1:	9.3	↗
2:	10.1	↗
<b>Series</b>		<b>19.4</b>
		136.9

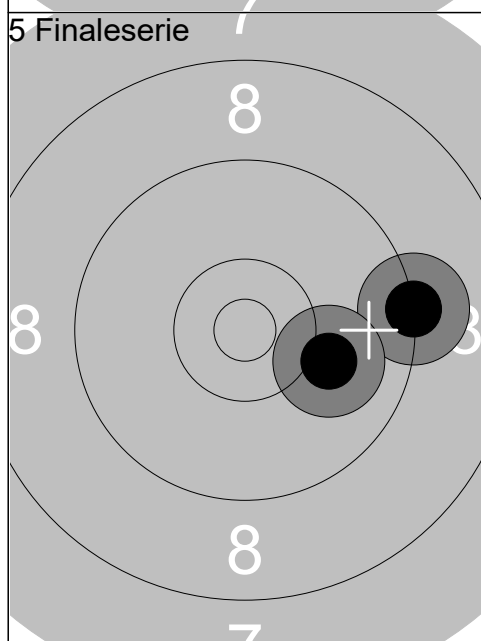

1:	9.2	→
2:	10.0	→
<b>Series</b>		<b>19.2</b>
		156.1

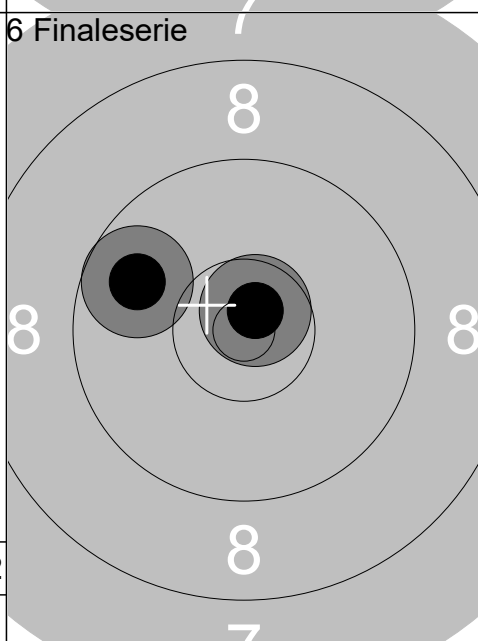

1:	10.7x	↗
2:	9.8	↙
<b>Series</b>		<b>20.5</b>
		176.6

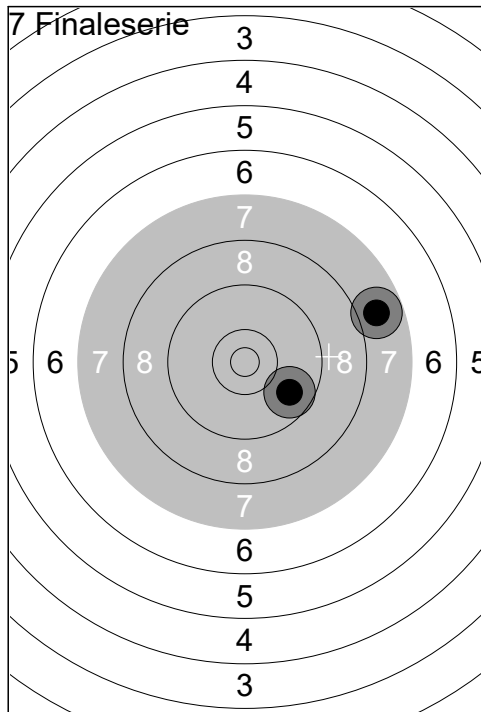

1: 7.8 →  
2: 9.8 ↘

Series	17.6
	194.2

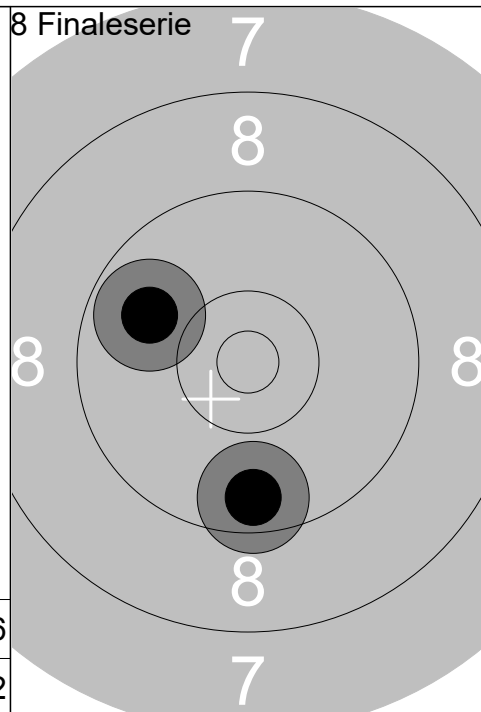

1: 9.6 ↓  
2: 9.8 ↙

Series	19.4
	213.6

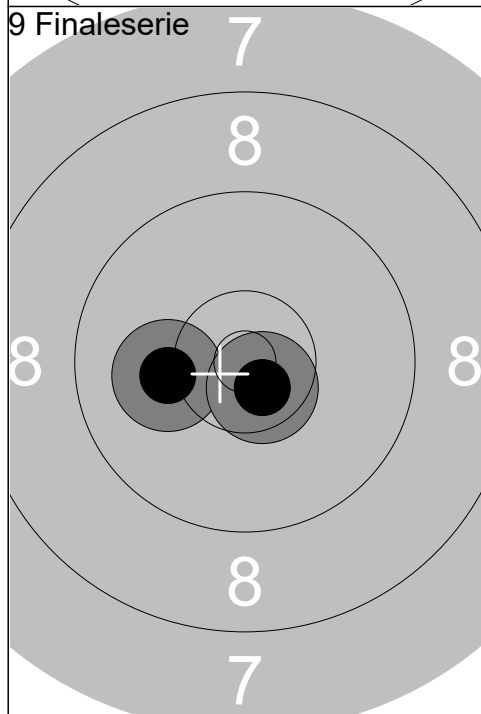

1: 10.2 ←  
2: 10.6x ↘

Series	20.8
	234.4

Relay	Lane	Flemming Jensen			
Day 3 Final		Rødovre Skytteforening	Mp		
24.01.2021		GMO2021 Day 3	Gundsøllille OPEN 2021		
1 Finaleserie		1: 9.3 ↙ 2: 10.2 ↑ 3: 9.3 → 4: 9.9 → 5: 8.8 ↘	2 Finaleserie		1: 8.5 ↘ 2: 10.2 ← 3: 10.8x ↑ 4: 9.1 → 5: 10.3 ↓
	Series 47.5		Series 48.9		
	47.5		96.4		
3 Finaleserie		1: 7.4 ← 2: 10.1 ↗	4 Finaleserie		1: 10.2 ↘ 2: 9.1 ↗
	Series 17.5		Series 19.3		
	113.9		133.2		
5 Finaleserie		1: 7.8 ↘ 2: 8.3 ←	6 Finaleserie		1: 10.4x → 2: 9.9 ↓
	Series 16.1		Series 20.3		
	149.3		169.6		

Gundsøllille Megalink Open 2021

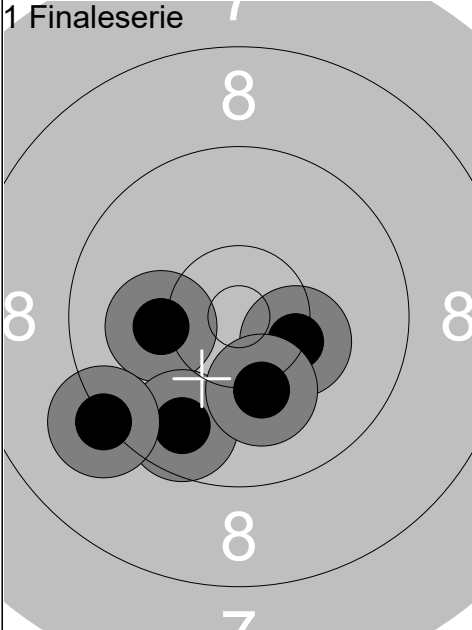
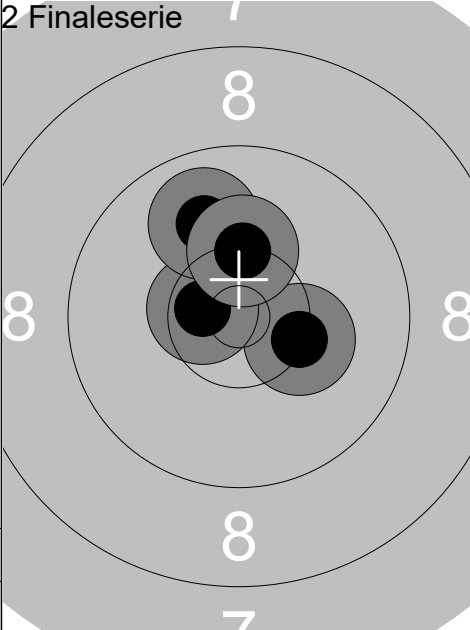
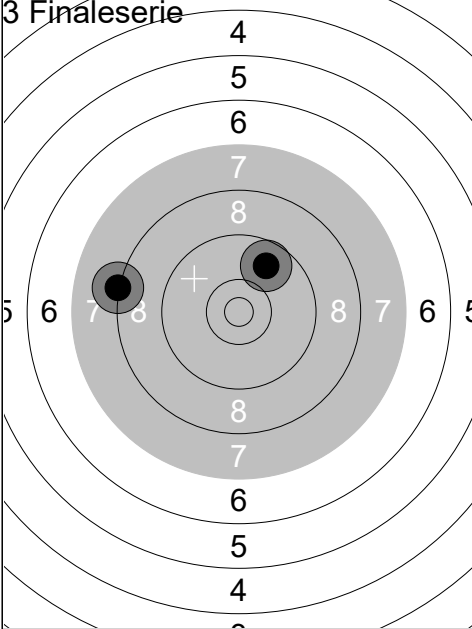
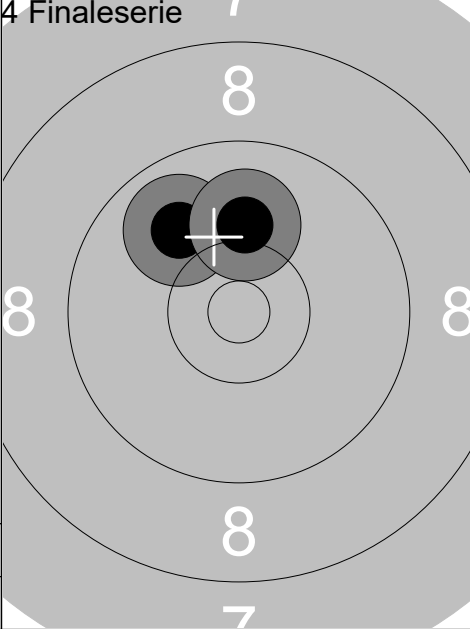
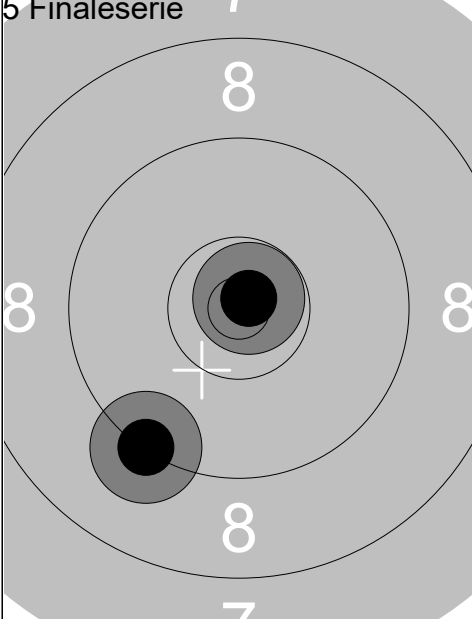
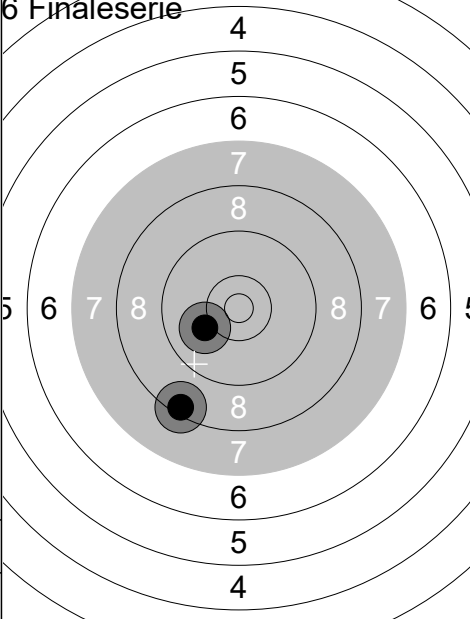
Relay	Lane	Frederik Larsen			
Day 3 Final		DSB/ASF	Mp		
24.01.2021		GMO2021 Day 3	Gundsøllille OPEN 2021		
1 Finaleserie		1: 10.2 ← 2: 10.3 → 3: 9.7 ↓ 4: 9.2 ↙ 5: 10.2 ↓	2 Finaleserie		1: 10.4x ↑ 2: 10.3 → 3: 10.6x ← 4: 9.9 ↑ 5: 10.3 ↑
	Series 49.6		Series 51.5		
	49.6		101.1		
3 Finaleserie		1: 9.8 ↗ 2: 8.2 ←	4 Finaleserie		1: 9.9 ↖ 2: 10.1 ↑
	Series 18.0		Series 20.0		
	119.1		139.1		
5 Finaleserie		1: 9.3 ↓ 2: 10.8x ↗	6 Finaleserie		1: 8.4 ↓ 2: 10.1 ←
	Series 20.1		Series 18.5		
	159.2		177.7		

Gundsøllille Megalink Open 2021

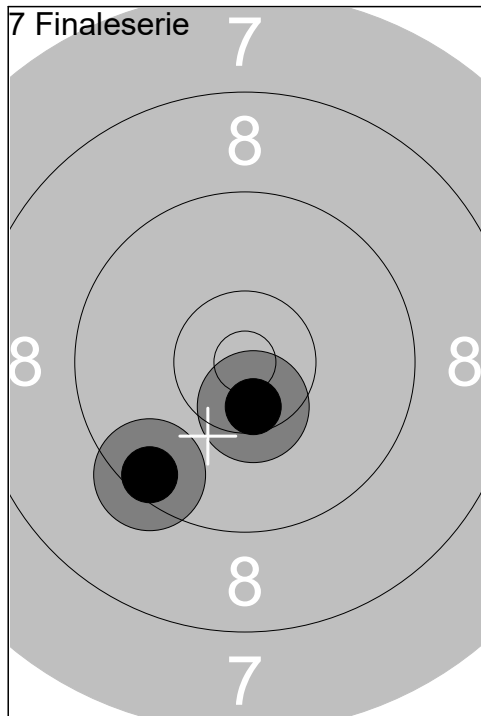

1: 9.4 ↙  
2: 10.5x ↓

Series	19.9
	197.6

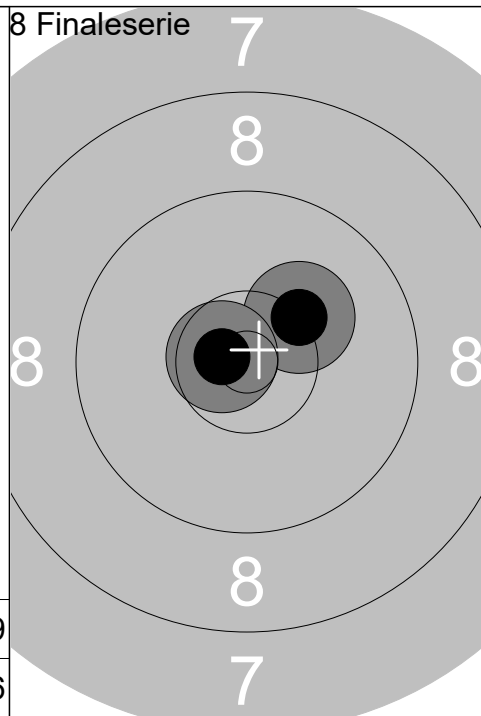

1: 10.2 ↗  
2: 10.7x ↖

Series	20.9
	218.5

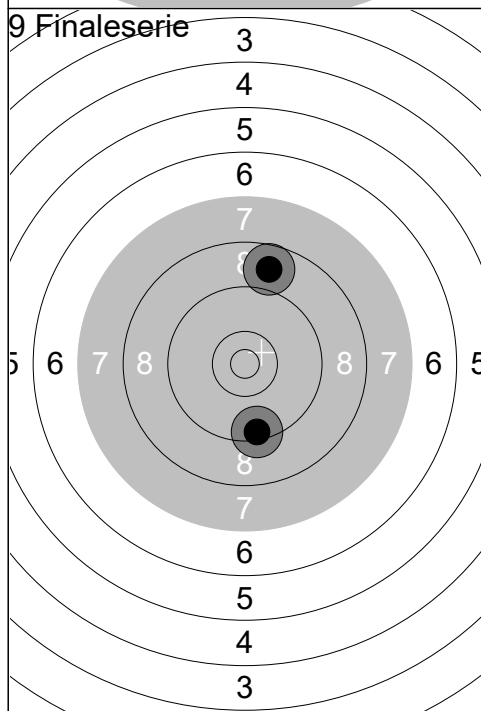

1: 9.4 ↓  
2: 8.8 ↑

Series	18.2
	236.7

Relay <b>2</b>	Lane <b>6</b>	<b>Steen Pedersen</b>	
Day 3 Final		Greve Skytteforening	Mp
24.01.2021		GMO2021 Day 3	Gundsøllille OPEN 2021
1 Finaleserie		1: 10.5x ↗ 2: 9.5 ↑ 3: 10.5x ↓ 4: 9.5 ↖ 5: 10.0 ↑	2 Finaleserie
		Series 50.0	
		50.0	1: 9.7 ↘ 2: 8.6 ↑ 3: 10.2 ↘ 4: 8.6 ↖ 5: 10.2 ↑
3 Finaleserie		1: 8.9 ← 2: 9.4 ↑	4 Finaleserie
		Series 18.3	
		115.6	1: 9.0 ← 2: 9.3 ↓
5 Finaleserie		1: 9.8 → 2: 9.6 ↘	6 Finaleserie
		Series 19.4	
		153.3	1: 8.8 ↖ 2: 8.8 ↘
7 Finaleserie		1: 10.4x → 2: 9.8 ↓	
		Series 20.2	
		191.1	



Relay	Lane	Michelle Leth Wehage			
Day 3 Final		Nykøbing Sj. Skytteforening	Wp		
24.01.2021		GMO2021 Day 3	Gundsøllille OPEN 2021		
1 Finaleserie		1: 8.0 ↗ 2: 9.9 → 3: 9.6 ↗ 4: 10.1 ↖ 5: 10.7x ↘	2 Finaleserie		1: 10.3 ↗ 2: 9.6 ↗ 3: 9.7 ↘ 4: 10.7x ↖ 5: 10.3 ↘
		Series 48.3		Series 50.6	
		48.3		98.9	
3 Finaleserie		1: 9.9 → 2: 8.8 →	4 Finaleserie		1: 10.4x ← 2: 9.6 ↗
		Series 18.7		Series 20.0	
		117.6		137.6	
5 Finaleserie		1: 9.5 ↗ 2: 9.7 ↘	6 Finaleserie		1: 8.3 → 2: 9.8 ↗
		Series 19.2		Series 18.1	
		156.8		174.9	
7 Finaleserie		1: 10.5x ↖ 2: 9.7 ↗	8 Finaleserie		1: 8.7 ← 2: 9.2 ←
		Series 20.2		Series 17.9	
		195.1		213.0	