

Relay	Lane	Christinna Herskind	
Gundsøllille Megalink OPE	Aalborg Skyttekreds	W	
18.01.2020	GMO2020 Day 2	Gundsøllille OPEN 2020	
<b>Serie 1</b>	1: 10.8x → 2: 10.3x → 3: 9.6 → 4: 9.8 ↘ 5: 10.1 ← 6: 10.6x ↘ 7: 10.4x ↗ 8: 10.5x ↗ 9: 10.8x ↓ 10: 10.6x ↓ Series 103.5 103.5	<b>Serie 2</b>	1: 10.5x ↖ 2: 10.0 ↗ 3: 10.4x → 4: 10.4x ↖ 5: 10.4x → 6: 10.3x ← 7: 10.5x ← 8: 10.1 ← 9: 10.1 → 10: 10.9x → Series 103.6 207.1
<b>Serie 3</b>	1: 10.6x → 2: 9.9 ↓ 3: 10.2x ↓ 4: 10.7x ↓ 5: 10.5x ↓ 6: 10.5x ↓ 7: 10.7x ← 8: 10.8x → 9: 10.7x ← 10: 10.2x ↗ Series 104.8 311.9	<b>Serie 4</b>	1: 9.5 ↖ 2: 10.1 ↗ 3: 10.7x ↓ 4: 10.7x ← 5: 10.8x ↑ 6: 10.7x ← 7: 10.6x → 8: 10.9x ↑ 9: 10.6x ↙ 10: 10.4x ↓ Series 105.0 416.9
<b>Serie 5</b>	1: 10.7x ↑ 2: 10.6x ↙ 3: 10.5x ↗ 4: 10.2x ↖ 5: 10.6x ↑ 6: 10.8x ↑ 7: 10.6x ↗ 8: 10.7x → 9: 10.7x ↗ 10: 10.4x ↖ Series 105.8 522.7	<b>Serie 6</b>	1: 10.6x ↗ 2: 10.6x ← 3: 10.9x → 4: 10.2x ↗ 5: 10.3x ↑ 6: 10.8x ↖ 7: 10.1 ← 8: 10.3x ↓ 9: 10.4x → 10: 10.5x ↖ Series 104.7 627.4

Relay	Lane	Rikke Mæng Ibsen	
1	2	Gundsøllille Megalink OPE	Trehøje Skytteforening
18.01.2020		GMO2020 Day 2	Gundsøllille OPEN 2020
Serie 1			1: 10.6x ↗ 2: 10.4x ↖ 3: 10.8x ↙ 4: 10.5x ↖ 5: 10.4x ↗ 6: 10.5x ↗ 7: 10.5x ↘ 8: 10.5x ← 9: 10.8x ↘ 10: 10.7x ↘ Series 105.7 105.7
Serie 2			1: 10.3x → 2: 10.1 → 3: 10.2x ↘ 4: 10.4x ← 5: 10.5x ↘ 6: 10.4x ↗ 7: 10.5x ↗ 8: 10.5x ↘ 9: 10.1 → 10: 10.8x ↗ Series 103.8 209.5
Serie 3			1: 10.3x ↖ 2: 10.3x ← 3: 10.6x → 4: 10.6x → 5: 10.3x ↘ 6: 10.3x → 7: 10.0 ↙ 8: 10.7x ↘ 9: 10.8x ↘ 10: 10.7x ← Series 104.6 314.1
Serie 4			1: 10.3x ↘ 2: 10.3x ↗ 3: 10.5x ← 4: 10.8x → 5: 10.6x ← 6: 10.7x ← 7: 10.0 ← 8: 10.7x ↖ 9: 10.2x ← 10: 10.9x ↘ Series 105.0 419.1
Serie 5			1: 10.5x ← 2: 10.5x → 3: 10.5x ↘ 4: 10.6x ← 5: 10.5x ↘ 6: 10.6x ↗ 7: 10.6x → 8: 10.6x ← 9: 10.4x ↖ 10: 10.5x ↘ Series 105.3 524.4
Serie 6			1: 10.6x ↖ 2: 10.3x ↙ 3: 10.7x ↖ 4: 10.3x ↑ 5: 10.7x → 6: 10.3x ← 7: 10.8x → 8: 10.1 ↘ 9: 10.2x → 10: 9.9 ← Series 103.9 628.3

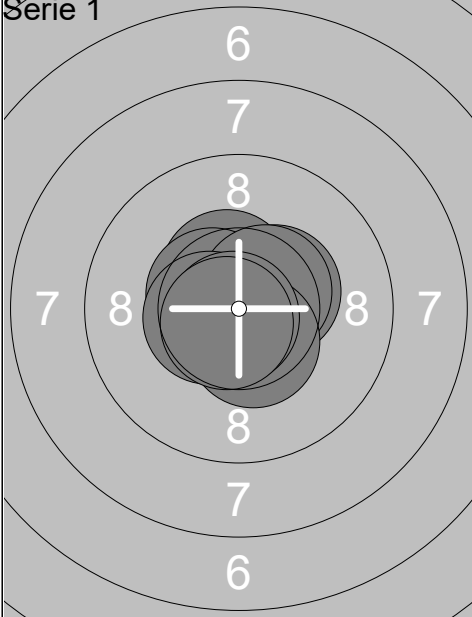

1:	10.3x ↓
2:	9.3 ↓
3:	10.2x ↑
4:	10.2x ↘
5:	10.7x ←
6:	10.4x →
7:	10.4x ↙
8:	10.7x ↖
9:	10.4x ↑
10:	10.1 ↙
<b>Series</b>	<b>102.7</b>
	<b>102.7</b>

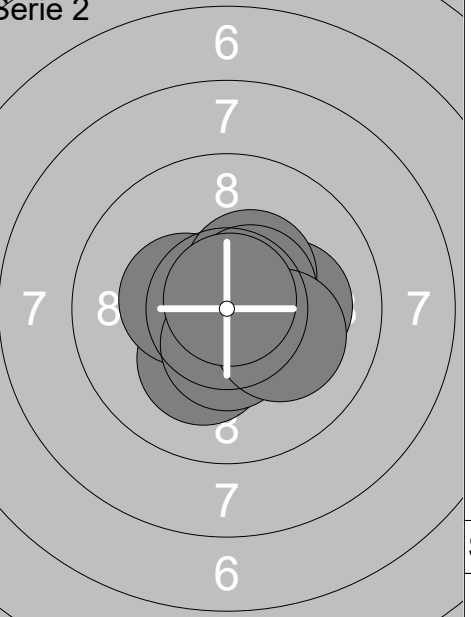
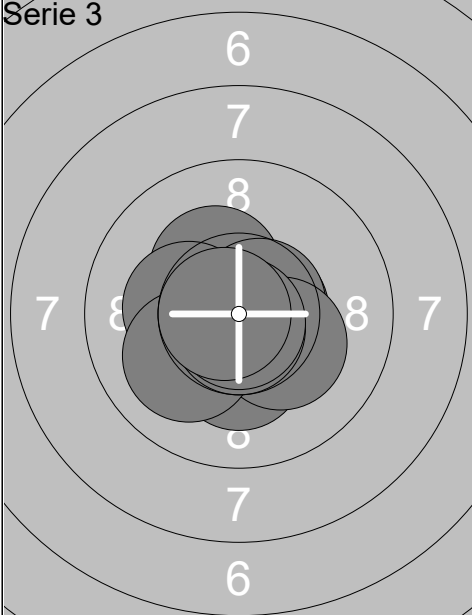
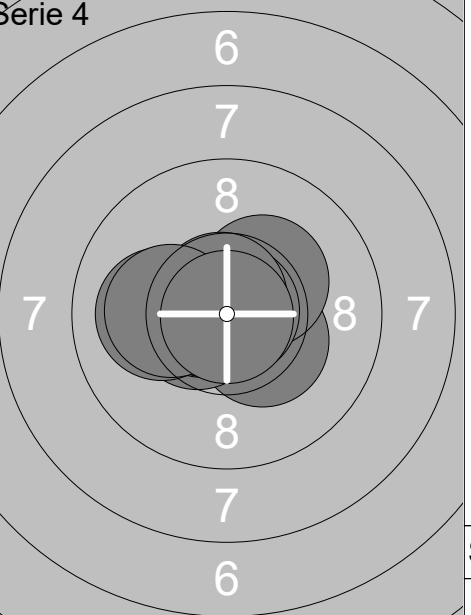
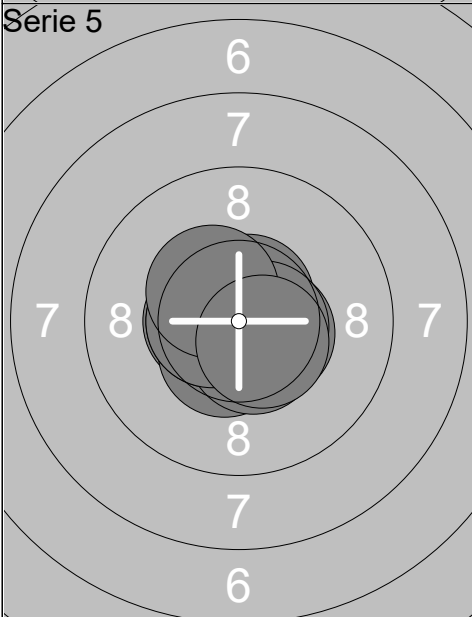
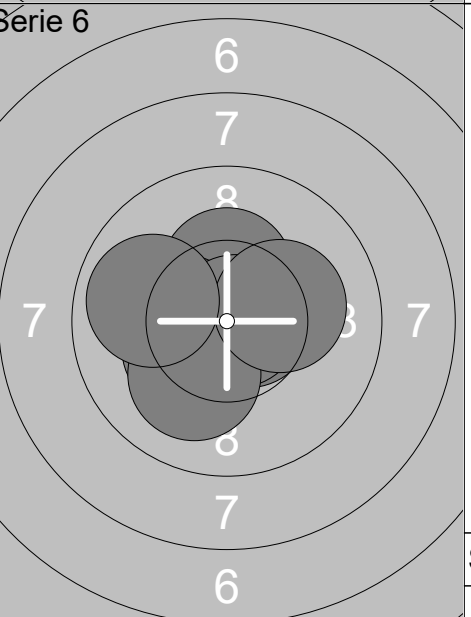
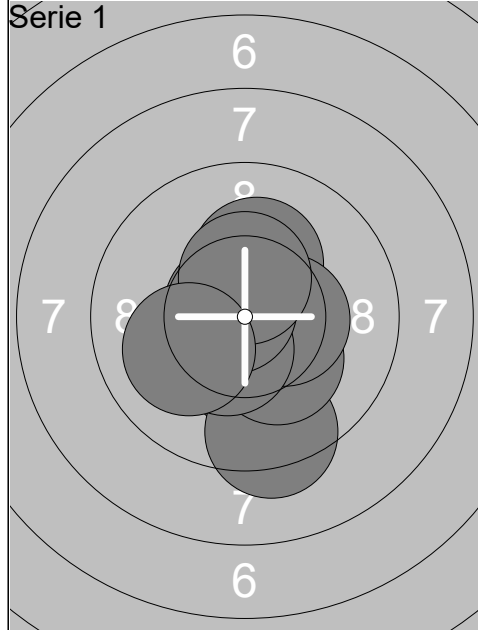
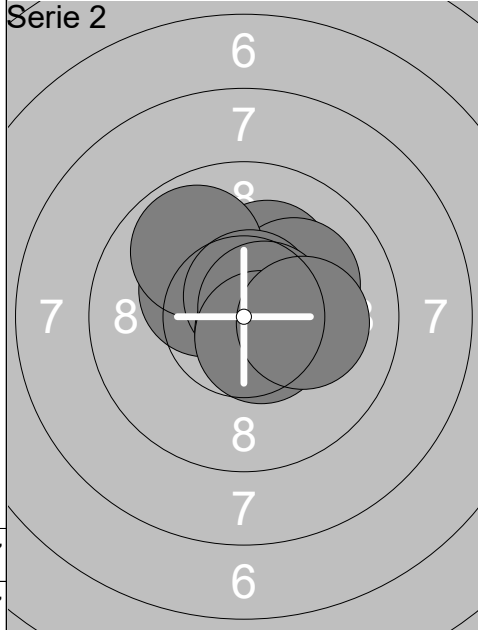

1:	10.6x ↗
2:	10.3x ↖
3:	10.2x ↑
4:	10.1 ↗
5:	9.8 ↖
6:	10.6x ↑
7:	10.6x ↘
8:	10.6x →
9:	10.6x ↘
10:	10.1 →
<b>Series</b>	<b>103.5</b>
	<b>206.2</b>

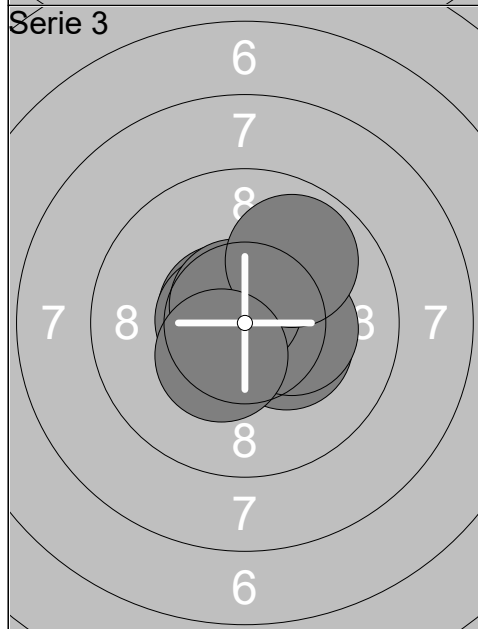

1:	10.8x ↖
2:	10.6x ↖
3:	10.4x →
4:	10.7x ↑
5:	10.3x →
6:	10.6x ←
7:	10.3x →
8:	10.7x ↖
9:	9.9 ↗
10:	10.4x ↙
<b>Series</b>	<b>104.7</b>
	<b>310.9</b>

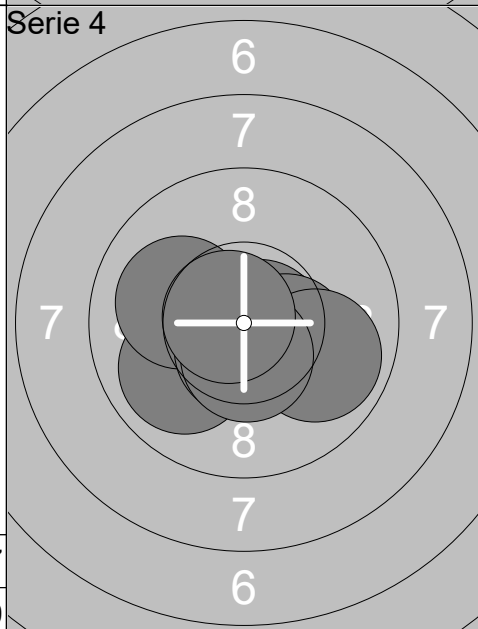

1:	9.9 ↙
2:	10.0 ←
3:	10.6x ↓
4:	10.6x →
5:	10.7x →
6:	10.3x →
7:	10.6x ↓
8:	9.9 →
9:	10.5x ↓
10:	10.7x ↖
<b>Series</b>	<b>103.8</b>
	<b>414.7</b>

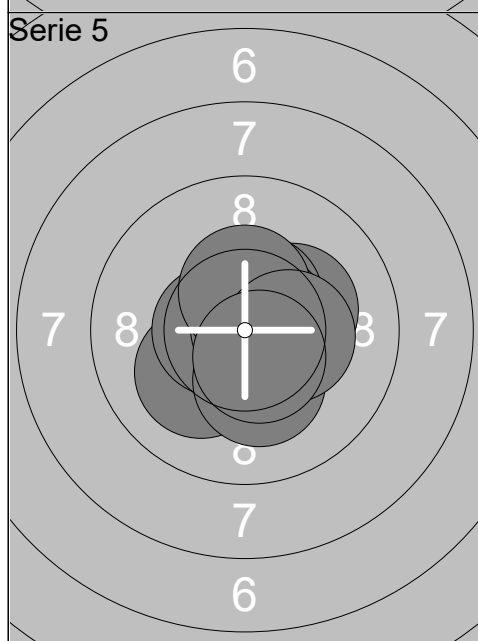

1:	10.1 ↙
2:	10.2x →
3:	10.5x ↑
4:	10.6x ↗
5:	10.6x ←
6:	10.8x →
7:	10.4x ↑
8:	10.2x ↓
9:	10.3x →
10:	10.5x ↘
<b>Series</b>	<b>104.2</b>
	<b>518.9</b>

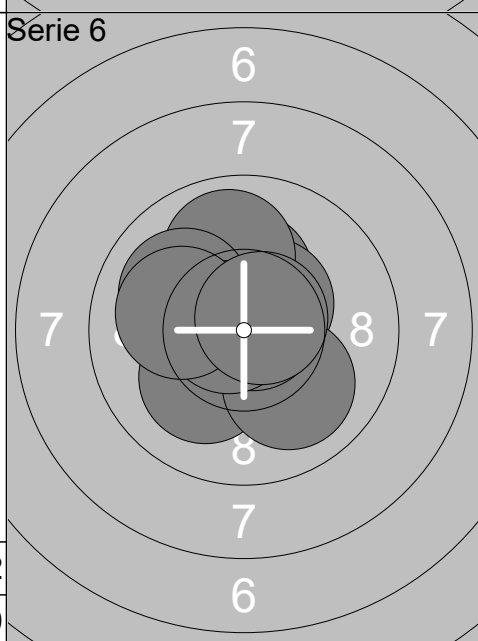

1:	10.2x ↑
2:	10.4x ↗
3:	10.1 ↙
4:	9.9 ↑
5:	10.0 ↘
6:	10.8x ↗
7:	10.0 ↖
8:	10.7x ←
9:	10.0 ←
10:	10.6x ↗
<b>Series</b>	<b>102.7</b>
	<b>621.6</b>

Relay <b>1</b>	Lane <b>4</b>	<b>Simone Berg</b>	
-------------------	------------------	--------------------	--

Gundsøllille Megalink OPE	Aalborg Skyttekreds	W	
---------------------------	---------------------	---	--

18.01.2020	GMO2020 Day 2	Gundsøllille OPEN 2020
------------	---------------	------------------------

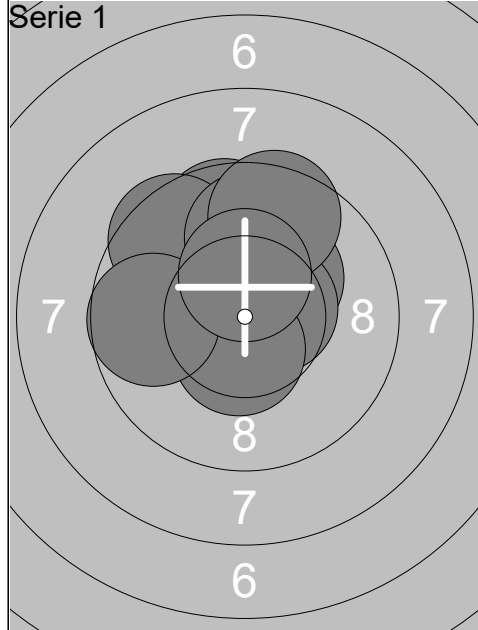

1:	10.2x ↗
2:	9.9 ←
3:	9.6 ↑
4:	9.5 ↗
5:	10.5x →
6:	10.5x ↓
7:	9.8 ↑
8:	9.5 ↑
9:	9.7 ←
10:	10.4x ↑
Series	99.6
	99.6

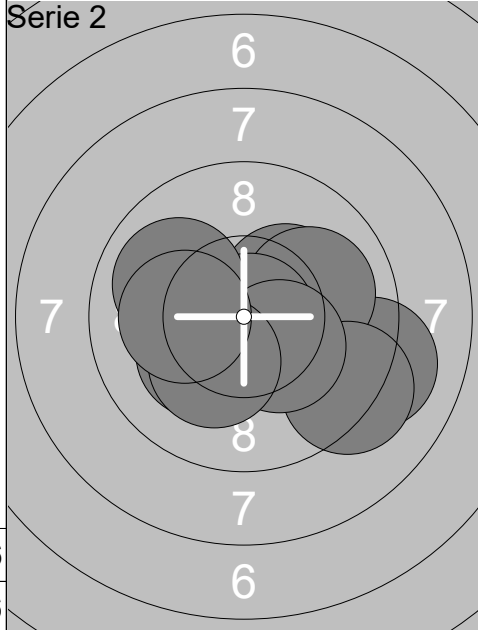

1:	9.1 →
2:	10.3x ↗
3:	10.0 →
4:	9.2 ↘
5:	10.2x ↙
6:	10.8x →
7:	9.9 ↖
8:	10.3x ↘
9:	10.2x ↙
10:	10.1 ←
Series	100.1
	199.7

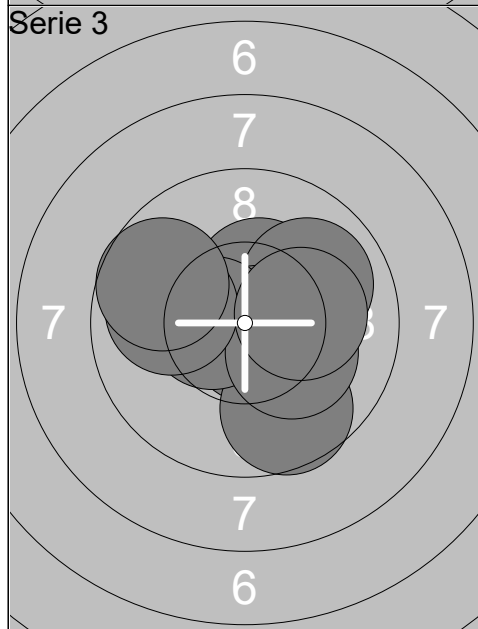

1:	10.7x ↘
2:	10.4x ↑
3:	9.9 →
4:	10.7x ↘
5:	9.6 ↓
6:	10.5x ←
7:	10.2x ↘
8:	9.9 ←
9:	9.7 ↖
10:	10.2x →
Series	101.8
	301.5

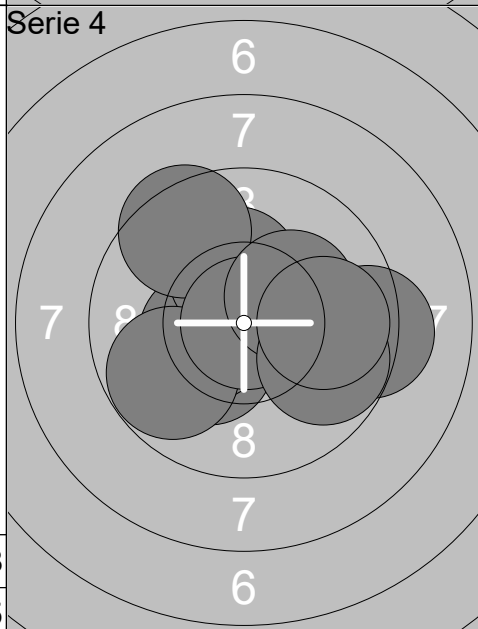

1:	10.2x ↙
2:	10.4x ←
3:	10.2x ↑
4:	9.4 ↗
5:	9.8 ↙
6:	10.9x →
7:	10.2x ↗
8:	9.2 →
9:	9.7 →
10:	9.8 →
Series	99.8
	401.3

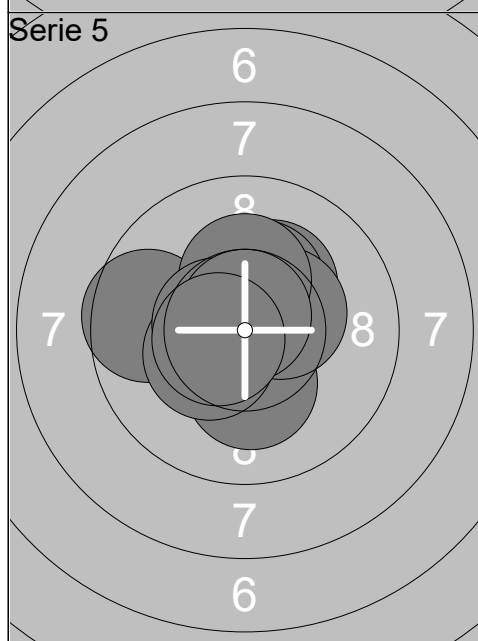

1:	10.2x ↗
2:	9.6 ←
3:	10.3x ↑
4:	10.2x ↓
5:	10.4x →
6:	10.3x ↑
7:	10.3x ↙
8:	10.5x ←
9:	10.7x ↑
10:	10.6x ←
Series	103.1
	504.4

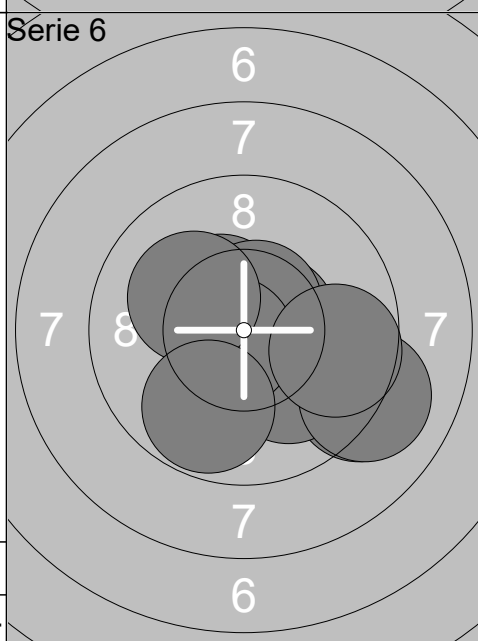

1:	10.4x ↗
2:	10.6x →
3:	9.1 ↘
4:	10.6x ↑
5:	10.0 ↘
6:	9.1 ↘
7:	10.7x ↙
8:	10.1 ↖
9:	9.8 ↓
10:	9.7 →
Series	100.1
	604.5

Gundsøllille Megalink Open 2020

Relay	Lane	Stine Holtze Nielsen	
Gundsøllille Megalink OPE	Sørslev Skytteforening	W	
18.01.2020	GMO2020 Day 2	Gundsøllille OPEN 2020	
<b>Serie 1</b>	1: 10.4x ↗ 2: 10.2x ↑ 3: 10.3x ↗ 4: 10.6x ↑ 5: 10.2x ↙ 6: 10.3x ↑ 7: 10.2x ↘ 8: 10.6x → 9: 10.2x → 10: 10.1 ↗ Series 103.1 103.1	<b>Serie 2</b>	1: 10.4x ↗ 2: 10.0 ← 3: 10.5x ↗ 4: 9.5 ↖ 5: 10.4x ↘ 6: 10.8x ↖ 7: 10.1 ← 8: 10.4x ↓ 9: 10.2x ↘ 10: 10.2x ↘ Series 102.5 205.6
<b>Serie 3</b>	1: 10.4x ↙ 2: 10.7x ↘ 3: 10.6x ↘ 4: 10.5x ↘ 5: 10.1 ↓ 6: 10.9x ← 7: 10.2x ↗ 8: 10.2x ↖ 9: 10.6x ↘ 10: 10.8x ↖ Series 105.0 310.6	<b>Serie 4</b>	1: 10.5x ↗ 2: 10.3x ← 3: 10.2x ← 4: 10.5x ↖ 5: 10.9x ↗ 6: 10.8x ← 7: 10.8x ↓ 8: 10.6x ↓ 9: 10.5x ↓ 10: 10.5x ↙ Series 105.6 416.2
<b>Serie 5</b>	1: 10.5x ← 2: 10.5x ↗ 3: 10.5x ↘ 4: 10.8x ↘ 5: 10.2x ↘ 6: 10.7x ↙ 7: 10.7x ↙ 8: 10.6x ↗ 9: 10.3x ↖ 10: 10.7x ↗ Series 105.5 521.7	<b>Serie 6</b>	1: 10.2x ↗ 2: 10.5x ↖ 3: 10.5x ↖ 4: 10.5x ↖ 5: 10.0 ↗ 6: 10.4x ← 7: 10.7x ↓ 8: 10.2x ← 9: 10.5x ↓ 10: 10.7x ↙ Series 104.2 625.9

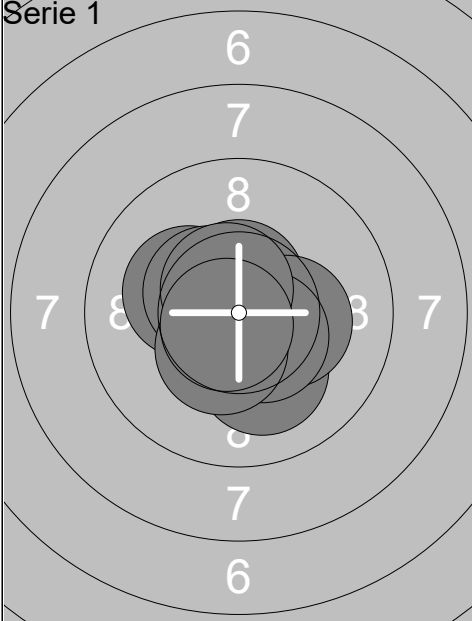
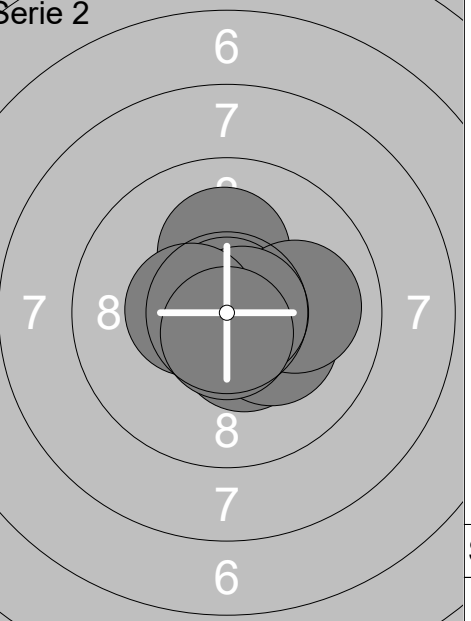
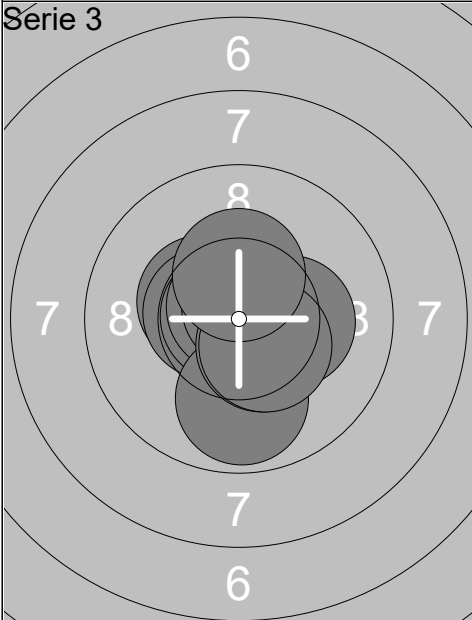
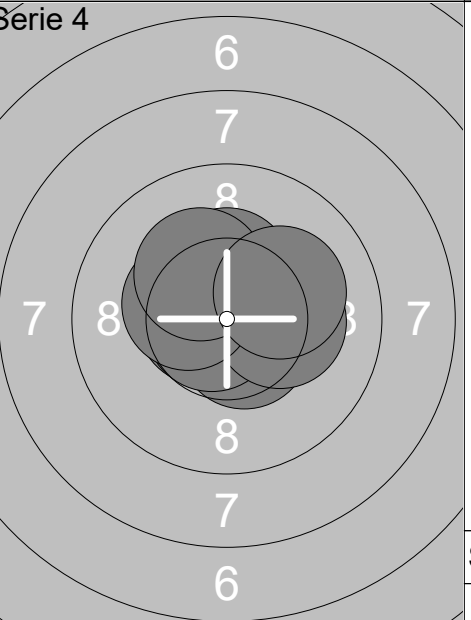
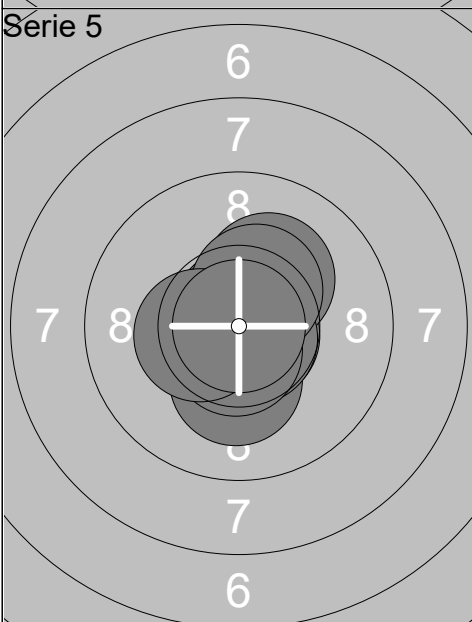
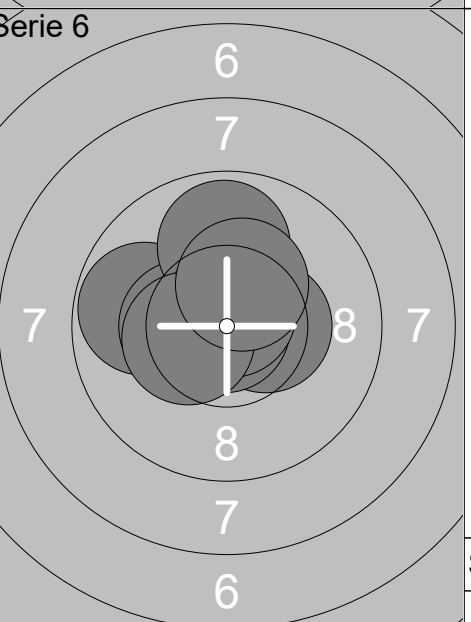
Relay	Lane	Anna Skade Nielsen	
1	7	Gundsøllille Megalink OPE	Sørslev Skytteforening
18.01.2020		GMO2020 Day 2	Gundsøllille OPEN 2020
Serie 1			1: 10.6x ↑ 2: 10.2x ↙ 3: 10.8x ↗ 4: 10.1 ↓ 5: 10.3x → 6: 10.5x ↘ 7: 10.4x ↖ 8: 10.6x ↗ 9: 10.4x ↘ 10: 10.7x ↙ Series 104.6 104.6
Serie 2			1: 10.4x ↘ 2: 10.6x ↑ 3: 10.5x ↗ 4: 10.2x ↘ 5: 10.1 ↑ 6: 10.8x ↑ 7: 10.0 → 8: 10.7x → 9: 10.5x ← 10: 10.6x ↓ Series 104.4 209.0
Serie 3			1: 10.4x ↖ 2: 10.5x ↖ 3: 10.8x ↖ 4: 10.7x ↗ 5: 10.7x ↗ 6: 9.8 ↓ 7: 10.4x ↘ 8: 10.2x → 9: 10.4x ↘ 10: 10.3x ↑ Series 104.2 313.2
Serie 4			1: 10.8x ↑ 2: 10.6x ← 3: 10.5x ↘ 4: 10.7x ← 5: 10.5x ↖ 6: 10.3x ↑ 7: 10.2x → 8: 10.4x ↖ 9: 10.2x ↖ 10: 10.1 ↗ Series 104.3 417.5
Serie 5			1: 10.7x ↘ 2: 10.2x ↗ 3: 10.8x ↑ 4: 10.2x ↓ 5: 10.7x ↘ 6: 10.6x ↓ 7: 10.8x ← 8: 10.4x ↗ 9: 10.4x ← 10: 10.9x Series 105.7 523.2
Serie 6			1: 10.7x ↗ 2: 10.4x → 3: 10.2x ↑ 4: 9.8 ← 5: 10.4x ← 6: 9.9 ↑ 7: 10.9x ← 8: 10.7x ↑ 9: 10.4x ← 10: 10.3x ↗ Series 103.7 626.9
Gundsøllille Megalink Open 2020			

Relay	Lane	Louise Madsen	
Gundsøllille Megalink OPE	Viborg Skytte Forening	W	
18.01.2020	GMO2020 Day 2	Gundsøllille OPEN 2020	
<b>Serie 1</b> 	1: 9.9 ↗	<b>Serie 2</b> 	1: 10.2x ↓
	2: 10.4x ↗		2: 10.3x ←
	3: 10.6x ↖		3: 10.0 ↙
	4: 10.8x ↓		4: 10.1 ↓
	5: 9.9 ↑		5: 10.3x →
	6: 10.5x →		6: 9.6 ↗
	7: 9.9 ↓		7: 10.5x ↓
	8: 10.0 ↑		8: 10.8x ↑
	9: 9.4 ↗		9: 10.0 ↑
	10: 9.8 ↘		10: 10.6x ↗
	<b>Series</b> 101.2	<b>Series</b> 102.4	
	101.2	203.6	
<b>Serie 3</b> 	1: 10.5x ↓	<b>Serie 4</b> 	1: 10.1 ↗
	2: 10.4x →		2: 10.2x ↗
	3: 10.6x ↘		3: 10.3x ↗
	4: 9.9 ↓		4: 10.6x ↖
	5: 10.1 ↗		5: 9.8 ↖
	6: 10.7x →		6: 10.1 ←
	7: 9.3 ↗		7: 10.0 ↓
	8: 10.0 →		8: 10.3x ↓
	9: 9.7 ↙		9: 10.7x ←
	10: 9.8 ↑		10: 10.3x ↑
	<b>Series</b> 101.0	<b>Series</b> 102.4	
	304.6	407.0	
<b>Serie 5</b> 	1: 10.1 ←	<b>Serie 6</b> 	1: 10.4x ↑
	2: 10.4x ↑		2: 10.7x ←
	3: 9.9 ←		3: 10.6x ↙
	4: 9.6 ↘		4: 10.7x →
	5: 10.4x ↗		5: 10.5x ↖
	6: 9.8 ←		6: 10.4x ↑
	7: 10.6x ↓		7: 10.2x ↓
	8: 10.0 ↑		8: 9.9 ←
	9: 10.0 ↖		9: 10.8x →
	10: 10.3x ↓		10: 10.3x ↖
	<b>Series</b> 101.1	<b>Series</b> 104.5	
	508.1	612.6	

Relay	Lane	Natasja Buchholdt	
Gundsøllille Megalink OPE	Ølstykke Skytteforening	W	
18.01.2020	GMO2020 Day 2	Gundsøllille OPEN 2020	
<b>Serie 1</b>	1: 10.7x ↙ 2: 10.4x ↗ 3: 10.5x ↗ 4: 10.1 ↓ 5: 10.4x ↓ 6: 10.3x ↙ 7: 9.7 ↖ 8: 10.2x ↙ 9: 10.5x ↖ 10: 10.5x ↖ Series 103.3 103.3	<b>Serie 2</b>	1: 10.3x ↘ 2: 10.3x → 3: 10.5x ↖ 4: 10.7x ↑ 5: 10.7x ↗ 6: 10.6x ↑ 7: 10.3x ↗ 8: 10.1 ↗ 9: 10.6x ↑ 10: 10.4x ↓ Series 104.5 207.8
<b>Serie 3</b>	1: 9.9 ↑ 2: 10.9x ↓ 3: 10.7x ↙ 4: 10.5x ↑ 5: 10.2x → 6: 10.3x ↙ 7: 10.2x ↙ 8: 10.5x ↙ 9: 9.7 → 10: 10.6x → Series 103.5 311.3	<b>Serie 4</b>	1: 10.0 → 2: 10.4x ↑ 3: 10.5x → 4: 10.0 → 5: 9.8 ↗ 6: 10.6x → 7: 9.7 ↓ 8: 10.5x → 9: 10.7x ↗ 10: 10.3x ↑ Series 102.5 413.8
<b>Serie 5</b>	1: 10.8x ↓ 2: 10.3x → 3: 10.5x ↙ 4: 10.2x ↙ 5: 10.7x ↙ 6: 10.5x ↗ 7: 10.5x ↓ 8: 10.6x ↓ 9: 9.6 ← 10: 10.1 ↓ Series 103.8 517.6	<b>Serie 6</b>	1: 10.6x → 2: 10.2x ↑ 3: 10.4x ↗ 4: 9.2 → 5: 10.8x ↑ 6: 9.8 ↗ 7: 10.5x → 8: 10.5x → 9: 10.5x ↙ 10: 10.4x ↙ Series 102.9 620.5

Gundsøllille Megalink Open 2020