

1:	9.6	↙
2:	7.8	↓
3:	8.5	→
4:	6.5	←
5:	10.2	↓
6:	9.6	←
7:	9.5	↓
8:	8.7	↓
9:	10.2	↗
10:	8.8	↓
Series		84 (0x)
		84 (0x)

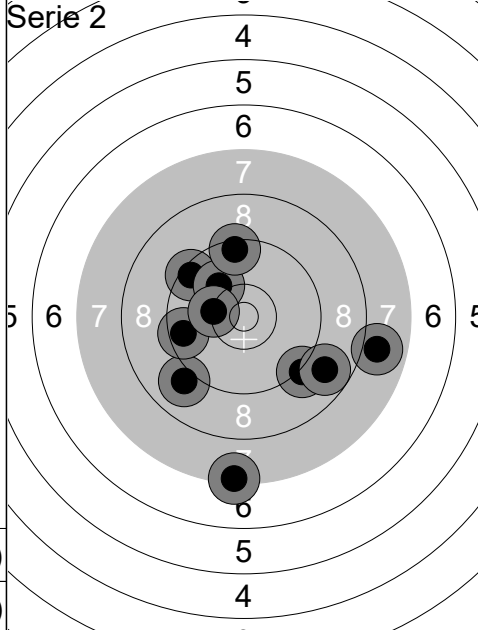

1:	9.4	↖
2:	9.0	↙
3:	7.3	↓
4:	10.1	↗
5:	9.4	↑
6:	9.5	←
7:	10.3	←
8:	9.1	↓
9:	7.9	→
10:	8.8	↘
Series		87 (0x)
		171 (0x)

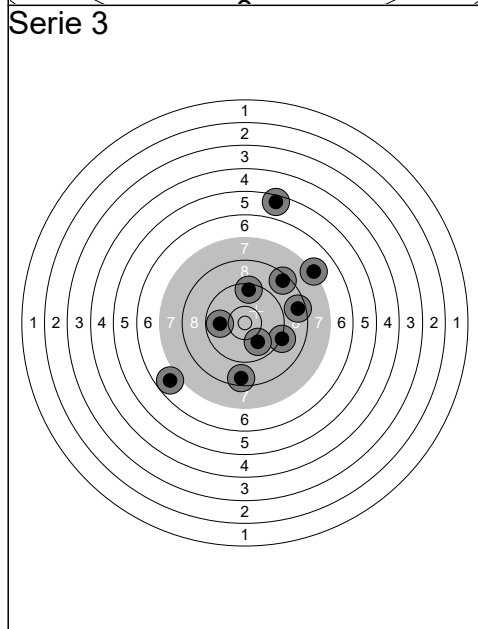

1:	5.5	↑
2:	7.2	↗
3:	6.8	↙
4:	9.2	→
5:	8.6	→
6:	8.5	↗
7:	9.8	←
8:	8.5	↓
9:	9.5	↑
10:	9.9	↓
Series		78 (0x)
		249 (0x)

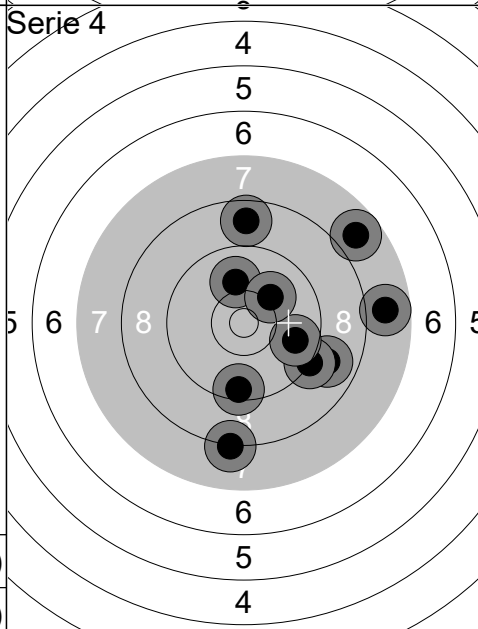

1:	9.5	↓
2:	8.9	→
3:	7.8	↗
4:	9.2	↘
5:	7.8	→
6:	10.0	↑
7:	8.7	↑
8:	9.7	→
9:	10.1	↗
10:	8.2	↓
Series		85 (0x)
		334 (0x)

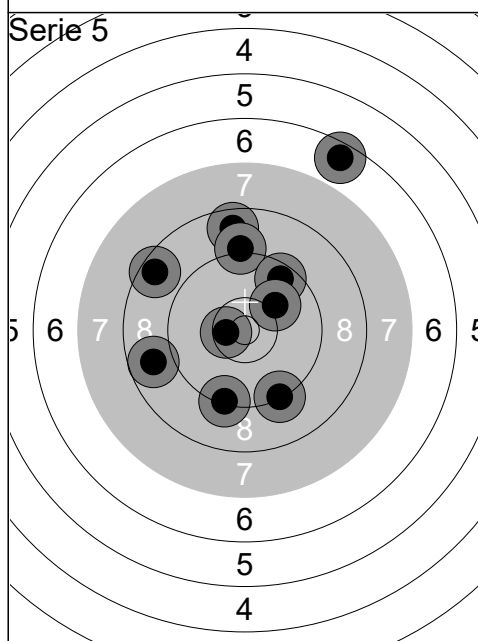

1:	9.3	↓
2:	8.8	←
3:	9.3	↓
4:	8.6	↑
5:	9.1	↑
6:	10.5x	←
7:	6.6	↗
8:	9.5	↗
9:	10.1	↗
10:	8.5	↖
Series		86 (1x)
		420 (1x)

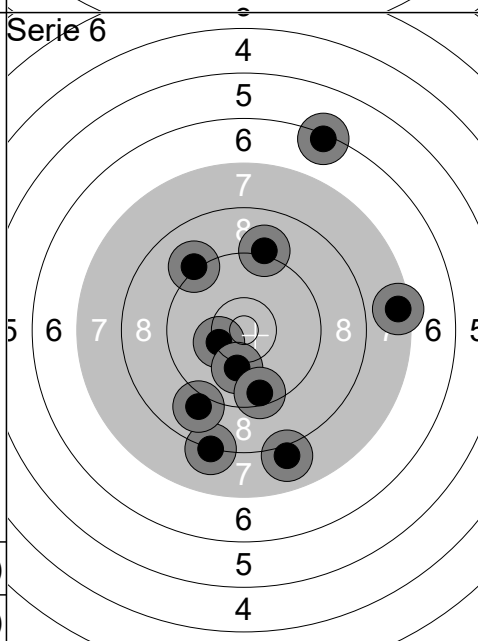

1:	8.0	↓
2:	9.1	↑
3:	9.1	↖
4:	8.2	↓
5:	10.3	←
6:	10.1	↓
7:	6.3	↗
8:	9.5	↓
9:	9.0	↓
10:	7.5	→
Series		85 (0x)
		505 (1x)

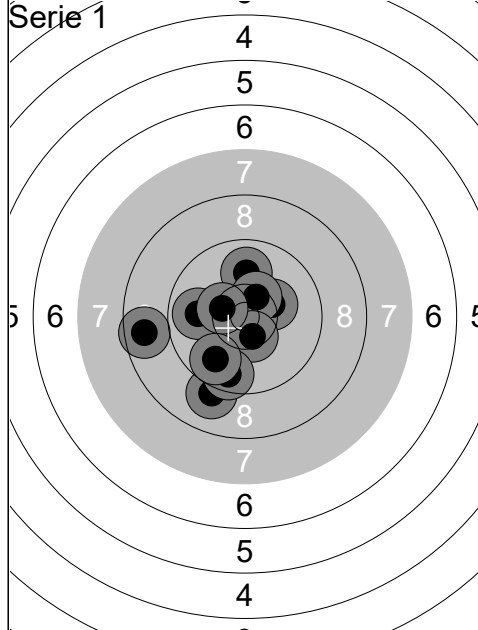

1:	10.0	↑
2:	10.3	→
3:	8.7	←
4:	10.4x	↗
5:	9.9	←
6:	10.5x	↘
7:	9.1	↘
8:	10.4x	↖
9:	9.6	↘
10:	9.8	↘
Series		94 (3x)
		94 (3x)

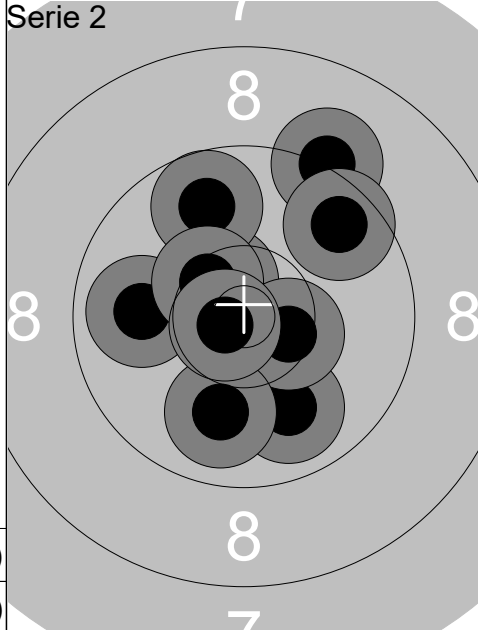

1:	9.2	↗
2:	10.5x	↖
3:	9.9	←
4:	9.9	↘
5:	10.5x	→
6:	9.8	↑
7:	10.4x	↖
8:	9.6	↗
9:	9.9	↘
10:	10.7x	↖
Series		94 (4x)
		188 (7x)

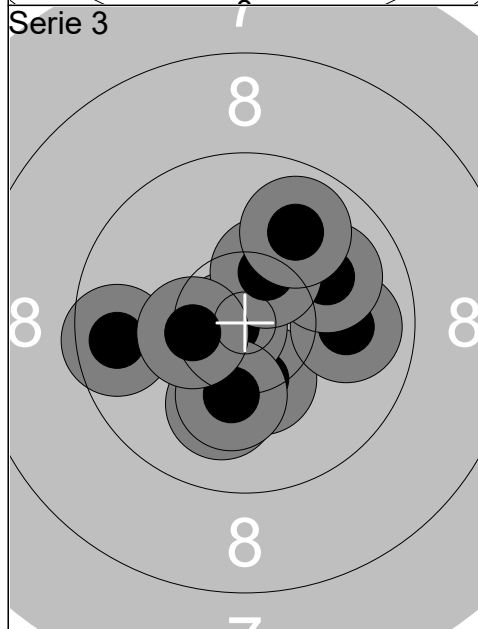

1:	10.1	↘
2:	10.4	↘
3:	9.6	←
4:	10.8x	↖
5:	10.2	↘
6:	9.9	→
7:	10.0	↗
8:	10.4x	↗
9:	9.9	↗
10:	10.4x	↖
Series		97 (3x)
		285 (10x)

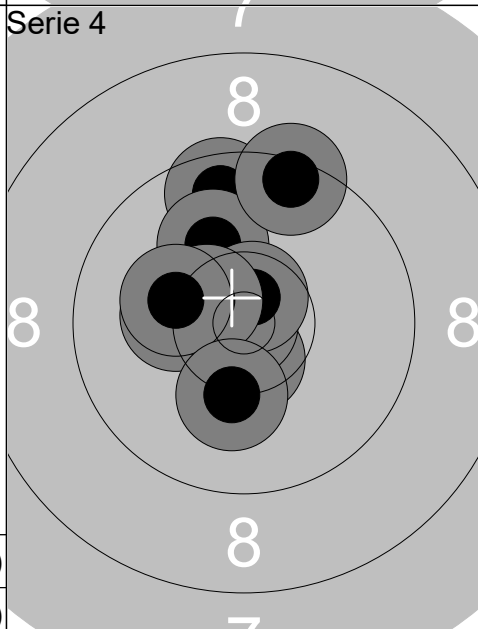

1:	10.6x	↘
2:	9.6	↑
3:	10.1	↗
4:	10.9x	↖
5:	10.3	←
6:	10.7x	↗
7:	9.4	↑
8:	10.5x	↖
9:	10.2	←
10:	10.2	↘
Series		98 (4x)
		383 (14x)

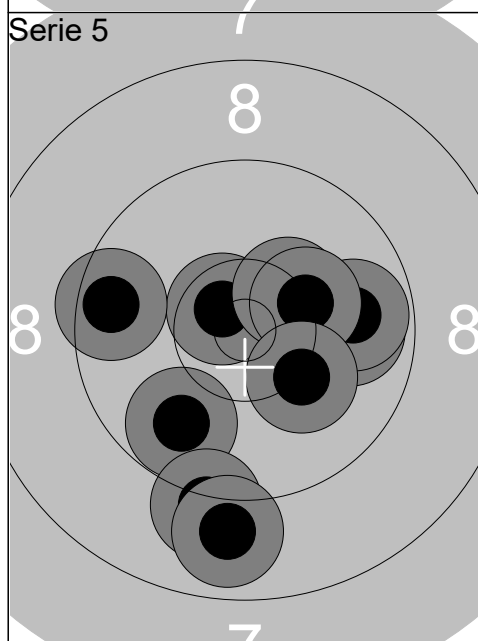

1:	9.9	→
2:	9.8	→
3:	10.6x	↖
4:	10.4x	↗
5:	9.8	↘
6:	9.6	←
7:	10.3	↗
8:	9.1	↘
9:	8.9	↘
10:	10.2	↘
Series		93 (2x)
		476 (16x)

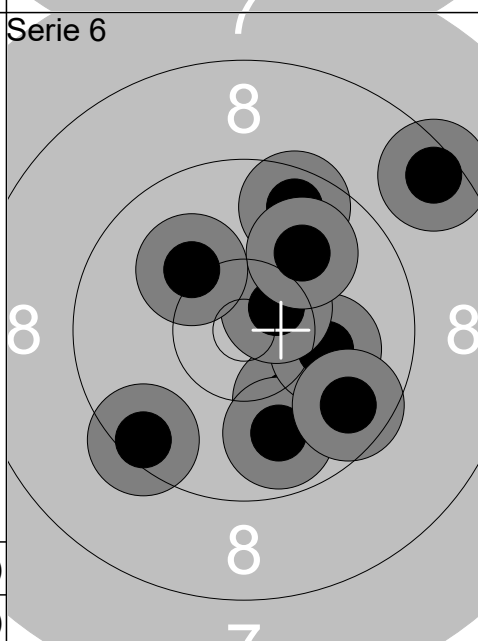

1:	10.1	↘
2:	9.4	↖
3:	9.8	↘
4:	10.1	→
5:	9.7	↘
6:	9.6	↑
7:	10.5x	↗
8:	8.5	↗
9:	10.0	↗
10:	10.1	↖
Series		94 (1x)
		570 (17x)

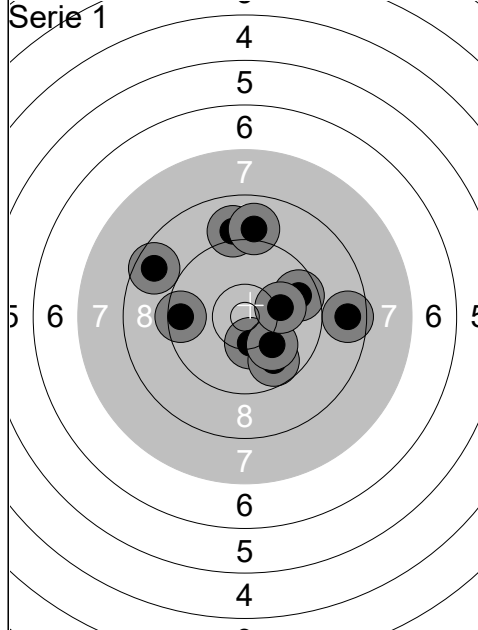

1:	8.6	→
2:	9.5	←
3:	8.6	↖
4:	9.0	↑
5:	10.3	↓
6:	9.6	→
7:	9.8	↘
8:	10.1	↘
9:	10.1	→
10:	9.0	↑
Series		91 (0x)
		91 (0x)

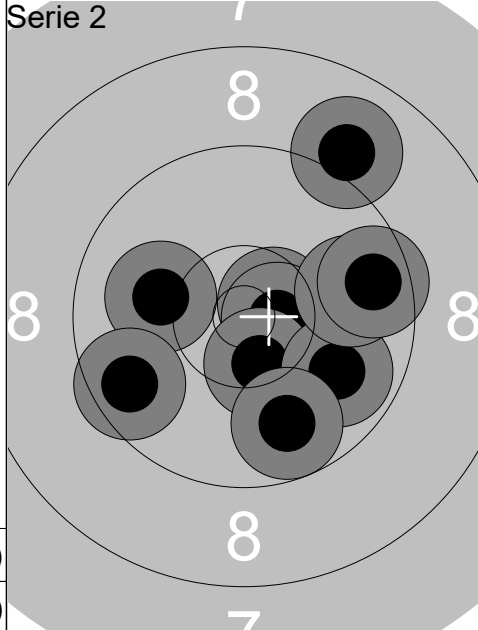

1:	10.6x	→
2:	10.6x	→
3:	10.4x	↓
4:	9.0	↗
5:	9.9	↘
6:	9.8	→
7:	9.6	→
8:	10.1	←
9:	9.8	↓
10:	9.6	↙
Series		94 (3x)
		185 (3x)

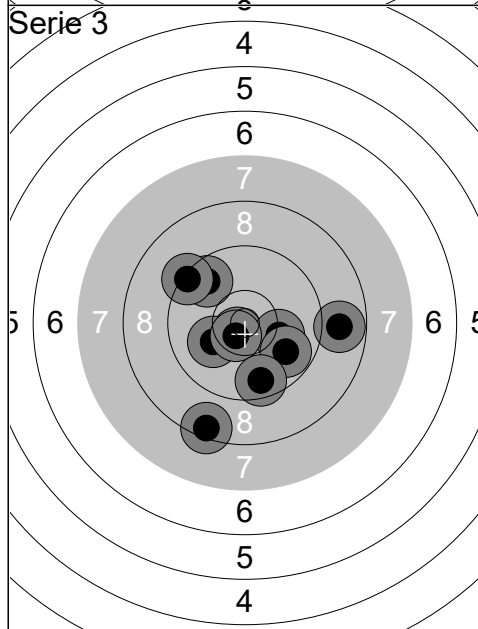

1:	9.7	↖
2:	8.4	↓
3:	10.7x	↘
4:	10.1	→
5:	8.8	→
6:	9.8	↘
7:	10.1	←
8:	10.6x	↘
9:	9.6	↓
10:	9.3	↖
Series		92 (2x)
		277 (5x)

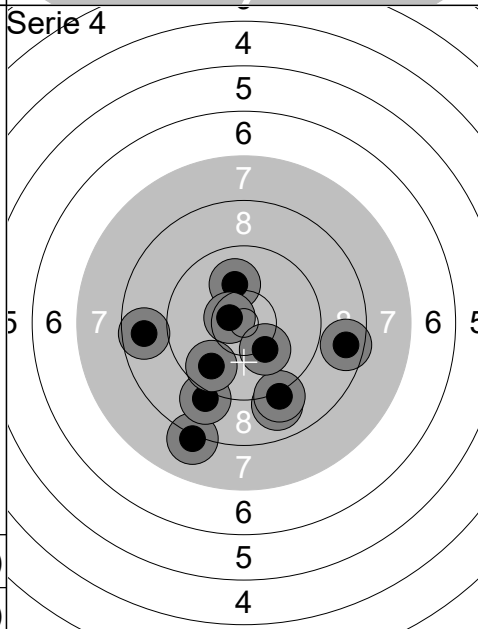

1:	9.0	↓
2:	10.1	↑
3:	10.6x	↖
4:	9.1	↓
5:	8.1	↓
6:	8.7	←
7:	8.6	→
8:	10.2	↘
9:	9.1	↓
10:	9.7	↘
Series		90 (1x)
		367 (6x)

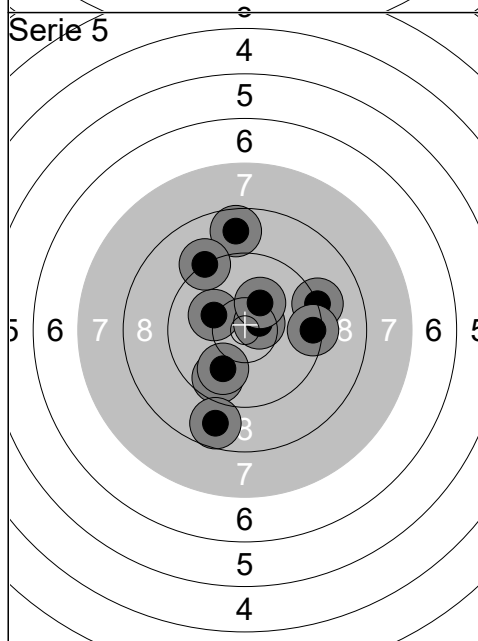

1:	8.7	↑
2:	9.7	↓
3:	10.2	↖
4:	9.2	→
5:	10.6x	→
6:	10.3	↗
7:	9.4	→
8:	10.0	↓
9:	8.8	↓
10:	9.2	↖
Series		92 (1x)
		459 (7x)

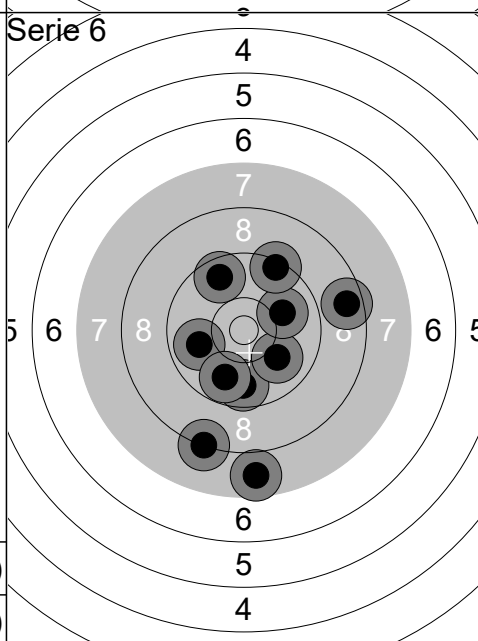

1:	9.7	↓
2:	8.2	↓
3:	9.9	←
4:	10.0	↘
5:	8.6	→
6:	9.6	↗
7:	9.8	↓
8:	10.0	→
9:	9.4	↗
10:	7.7	↓
Series		88 (0x)
		547 (7x)

Relay 4	Lane 4	Krister Persson		
Gundsøllille Megalink OPE		Klippans Pistolklubb	Mp	
18.01.2020		GMO2020 Day 2	Gundsøllille OPEN 2020	
Serie 1 		1: 10.4x ↗ 2: 10.0 ↘ 3: 7.9 ← 4: 8.8 ← 5: 7.8 ↑ 6: 8.6 ↑ 7: 8.2 ↗ 8: 8.7 ↓ 9: 8.1 ↗ 10: 9.8 ← Series 83 (1x) 83 (1x)	Serie 2 	1: 8.8 ← 2: 10.1 ↖ 3: 8.8 ↗ 4: 9.4 ↘ 5: 9.5 ↗ 6: 8.9 ← 7: 8.9 ↗ 8: 9.3 ← 9: 10.4 ↘ 10: 9.9 → Series 88 (0x) 171 (1x)
Serie 3 		1: 9.5 ← 2: 10.2 → 3: 9.2 ↓ 4: 10.4x ← 5: 10.0 ← 6: 9.9 ↘ 7: 9.4 ← 8: 9.2 ← 9: 10.4x ↙ 10: 8.9 ↑ Series 93 (2x) 264 (3x)	Serie 4 	1: 8.5 ← 2: 9.4 → 3: 8.3 ↘ 4: 10.3 ↓ 5: 10.1 ↖ 6: 10.0 ↗ 7: 10.2 ← 8: 9.3 ↓ 9: 10.4x ↗ 10: 9.8 ↘ Series 93 (1x) 357 (4x)
Serie 5 		1: 10.0 ← 2: 8.3 ↗ 3: 10.7x ↗ 4: 9.7 ↘ 5: 10.6x ← 6: 9.4 ↑ 7: 10.0 ↗ 8: 9.2 ↑ 9: 10.3 → 10: 8.0 ↖ Series 93 (2x) 450 (6x)	Serie 6 	1: 9.1 ← 2: 8.7 ↘ 3: 9.9 ↑ 4: 10.0 → 5: 9.8 ↗ 6: 10.3 ↘ 7: 9.2 ↖ 8: 9.7 ↗ 9: 8.8 ← 10: 9.5 ↑ Series 90 (0x) 540 (6x)

Relay	Lane	Arne Berg Søeballe		
4	5	Gundsøllille Megalink OPE	Greve Skytteforening	Mp
18.01.2020	GMO2020 Day 2	Gundsøllille OPEN 2020		
Serie 1 	1: 7.8 ↗	Serie 2 	1: 9.8 ↗	
	2: 5.6 ↗		2: 5.2 ↙	
	3: 9.0 ↘		3: 10.6x →	
	4: 2.2 ↙		4: 9.7 ↗	
	5: 7.6 ↓		5: 8.0 ↙	
	6: 8.5 ←		6: 8.4 ↙	
	7: 8.1 ↗		7: 6.9 ↓	
	8: 6.9 ↙		8: 9.5 ↓	
	9: 7.3 ↑		9: 6.2 ↓	
	10: 8.6 ↓		10: 8.6 ↙	
	Series 67 (0x)		Series 78 (1x)	
	67 (0x)		145 (1x)	
Serie 3 	1: 8.8 →	Serie 4 	1: 8.3 ↗	
	2: 7.8 ↓		2: 9.0 →	
	3: 6.6 ↙		3: 9.8 ↗	
	4: 8.0 ↑		4: 7.3 ↙	
	5: 9.7 ↗		5: 9.0 ←	
	6: 7.3 ←		6: 9.7 ↙	
	7: 4.6 ↘		7: 7.6 ↘	
	8: 10.8x →		8: 9.4 ↓	
	9: 8.4 ↙		9: 6.7 ↘	
	10: 8.7 ↑		10: 8.8 ↘	
	Series 75 (1x)		Series 81 (0x)	
	220 (2x)		301 (2x)	
Serie 5 	1: 7.3 ↓	Serie 6 	1: 9.7 ←	
	2: 8.3 ↓		2: 5.6 ↓	
	3: 8.7 →		3: 9.2 →	
	4: 7.7 ↓		4: 9.8 ↗	
	5: 8.3 ↓		5: 7.4 →	
	6: 7.7 ←		6: 8.4 ↑	
	7: 5.4 ↙		7: 7.1 ↘	
	8: 3.6 ↙		8: 10.6x ←	
	9: 9.0 ↗		9: 8.6 ←	
	10: 9.2 ↑		10: 10.6x ↗	
	Series 71 (0x)		Series 82 (2x)	
	372 (2x)		454 (4x)	

Relay 4	Lane 6	Erik Larsen		
Gundsøllille Megalink OPE		Korsør Skytteforening	Mp	
18.01.2020		GMO2020 Day 2	Gundsøllille OPEN 2020	
Serie 1 		1: 9.7 ↗ 2: 8.1 ↓ 3: 9.4 → 4: 10.2 → 5: 10.3 ↘ 6: 9.9 → 7: 9.9 ↗ 8: 7.0 ↘ 9: 8.3 → 10: 9.6 → Series 88 (0x) 88 (0x)	Serie 2 	1: 8.8 ↘ 2: 9.0 ↓ 3: 8.3 ↓ 4: 9.8 ↘ 5: 10.6x ← 6: 9.0 ← 7: 10.6x ↘ 8: 9.6 → 9: 7.3 ← 10: 10.4x ↘ Series 89 (3x) 177 (3x)
Serie 3 		1: 9.5 → 2: 9.0 ↑ 3: 8.8 ↘ 4: 7.8 ↗ 5: 7.7 ← 6: 9.1 ↓ 7: 7.7 → 8: 8.7 ← 9: 10.0 ← 10: 8.8 ↑ Series 82 (0x) 259 (3x)	Serie 4 	1: 9.3 ↘ 2: 10.5x → 3: 10.6x ↘ 4: 9.9 ↘ 5: 8.8 → 6: 9.4 ↓ 7: 8.8 → 8: 9.6 ↗ 9: 10.0 ↘ 10: 10.6x ↘ Series 92 (3x) 351 (6x)
Serie 5 		1: 8.8 → 2: 9.1 ↓ 3: 10.6x → 4: 9.7 → 5: 10.3 ↘ 6: 9.4 → 7: 9.6 → 8: 9.6 ↑ 9: 9.9 ↘ 10: 9.7 ↘ Series 91 (1x) 442 (7x)	Serie 6 	1: 9.7 → 2: 7.7 ↘ 3: 9.0 ← 4: 8.6 ← 5: 7.8 ↘ 6: 10.4x ↗ 7: 10.3 ↗ 8: 8.2 ← 9: 8.6 ↗ 10: 7.7 ↘ Series 83 (1x) 525 (8x)

Relay	Lane	Anders Kaa Bach	
4	7	Gundsøllille Megalink OPE	Århus Pistoltskytteforening
18.01.2020	GMO2020 Day 2	Gundsøllille OPEN 2020	
Serie 1		1: 8.4 ↑ 2: 10.1 ↓ 3: 9.1 ↓ 4: 9.6 ↙ 5: 8.8 ↘ 6: 10.3 ↑ 7: 9.8 ← 8: 7.6 ← 9: 8.6 → 10: 9.9 ↓ Series 87 (0x) 87 (0x)	Serie 2 1: 10.8x ↑ 2: 10.0 → 3: 10.3 ↙ 4: 9.7 ↓ 5: 10.6x ↑ 6: 9.9 → 7: 8.5 ↓ 8: 8.5 ↓ 9: 10.5x ↑ 10: 9.9 ↓ Series 93 (3x) 180 (3x)
Serie 3		1: 7.6 ↓ 2: 9.1 ← 3: 10.0 ↙ 4: 8.8 ↓ 5: 9.4 ↓ 6: 10.1 ↓ 7: 10.8x ↘ 8: 10.7x ↗ 9: 10.6x → 10: 10.0 ← Series 93 (3x) 273 (6x)	Serie 4 1: 8.3 ↓ 2: 10.5x ↑ 3: 10.1 ↑ 4: 10.3 ↗ 5: 8.0 ↑ 6: 8.8 ↙ 7: 10.2 ← 8: 9.3 ← 9: 10.3 ↙ 10: 10.4x ↑ Series 93 (2x) 366 (8x)
Serie 5		1: 9.4 ← 2: 10.8x → 3: 9.9 ↓ 4: 10.2 → 5: 9.3 ↙ 6: 10.1 ↓ 7: 10.2 ↑ 8: 8.7 ↗ 9: 9.1 ← 10: 9.5 ↗ Series 93 (1x) 459 (9x)	Serie 6 1: 10.8x ↓ 2: 10.3 ↗ 3: 7.8 ↑ 4: 8.5 ↑ 5: 9.1 ↗ 6: 10.1 ↙ 7: 9.3 ← 8: 9.2 ↓ 9: 9.2 → 10: 8.9 ↓ Series 89 (1x) 548 (10x)

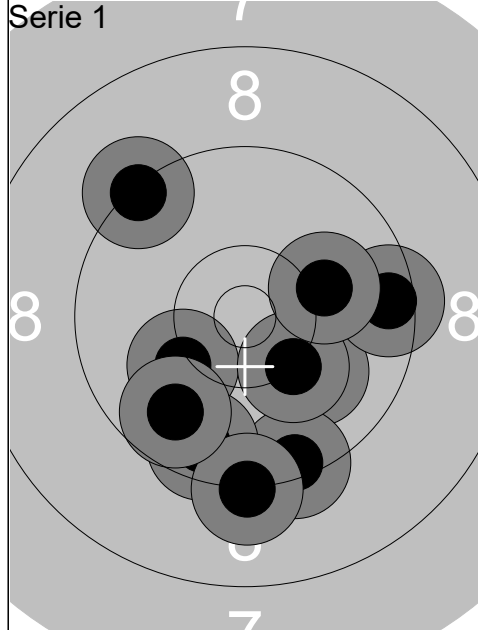

1:	10.1	↘
2:	10.1	↙
3:	9.4	↘
4:	9.6	↘
5:	9.3	↗
6:	9.2	↘
7:	9.8	↘
8:	9.5	→
9:	10.3	↘
10:	10.1	→
Series		94 (0x)
		94 (0x)

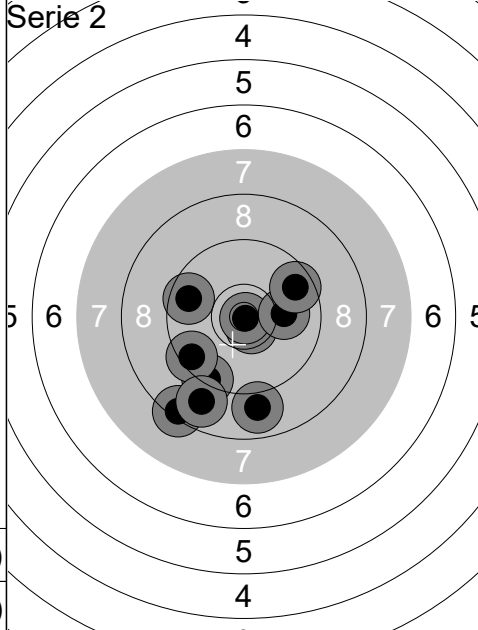

1:	8.4	↙
2:	9.3	↙
3:	8.9	↘
4:	9.5	↙
5:	10.6x	↘
6:	10.9x	↘
7:	10.0	→
8:	9.7	←
9:	9.6	↗
10:	8.8	↘
Series		90 (2x)
		184 (2x)

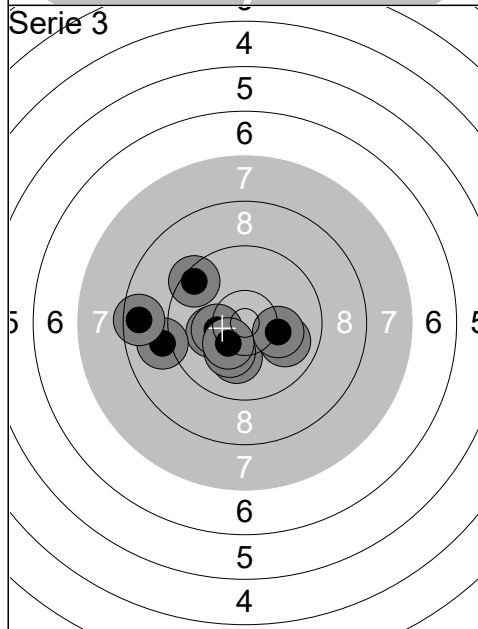

1:	10.1	↘
2:	10.2	←
3:	10.0	↗
4:	9.5	↗
5:	10.3	←
6:	9.0	←
7:	10.2	→
8:	10.2	↘
9:	8.6	←
10:	10.4x	↘
Series		96 (1x)
		280 (3x)

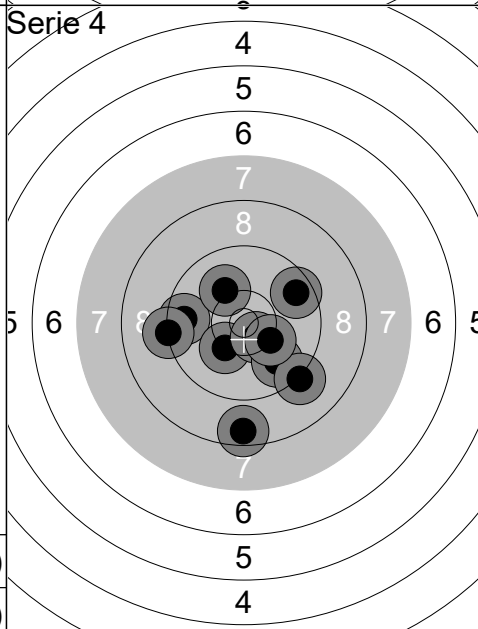

1:	9.6	←
2:	8.5	↘
3:	10.3	↘
4:	10.1	↗
5:	10.5x	↘
6:	9.8	↘
7:	9.6	↗
8:	9.2	↘
9:	9.3	←
10:	10.2	↘
Series		93 (1x)
		373 (4x)

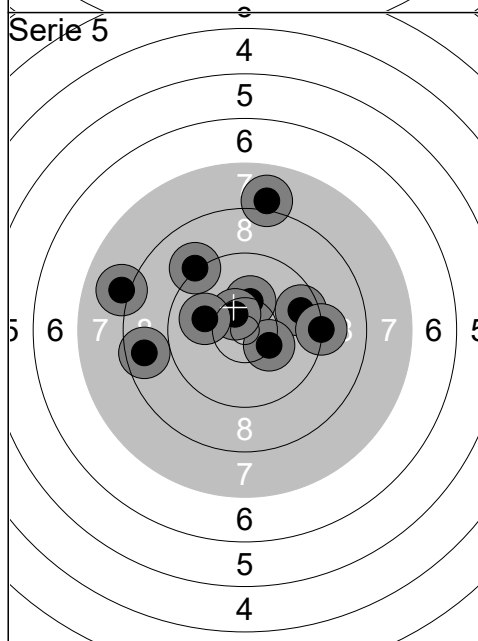

1:	8.1	←
2:	9.6	→
3:	9.2	↗
4:	9.2	→
5:	10.3	↑
6:	8.0	↑
7:	10.3	↘
8:	10.5x	↗
9:	8.6	←
10:	10.0	←
Series		91 (1x)
		464 (5x)

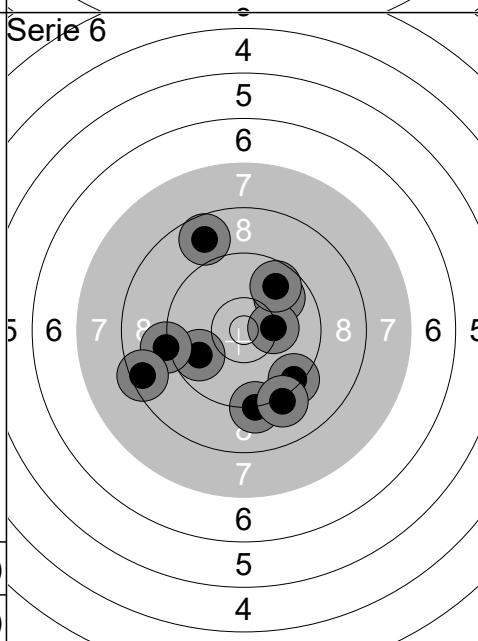

1:	9.9	↗
2:	10.3	→
3:	9.8	←
4:	9.4	↘
5:	9.2	←
6:	9.2	↘
7:	9.7	↗
8:	9.1	↘
9:	8.5	←
10:	8.7	↗
Series		89 (0x)
		553 (5x)

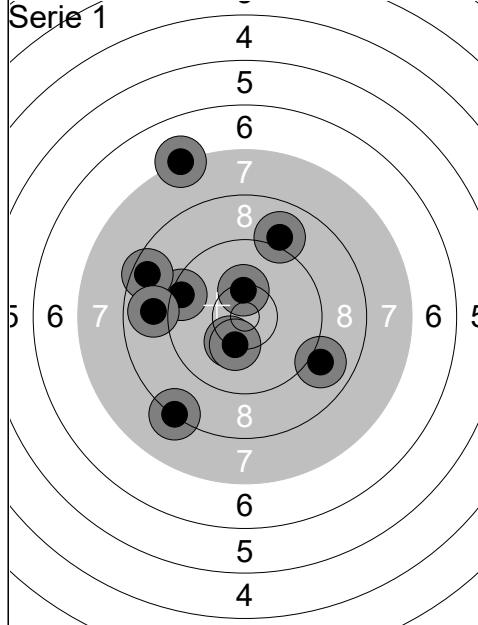

1:	7.2	↗
2:	9.0	↗
3:	10.4	↑
4:	9.4	↖
5:	8.3	↘
6:	10.3	↘
7:	9.0	↘
8:	10.3	↘
9:	8.6	↖
10:	8.9	↖
Series		88 (0x)
		88 (0x)

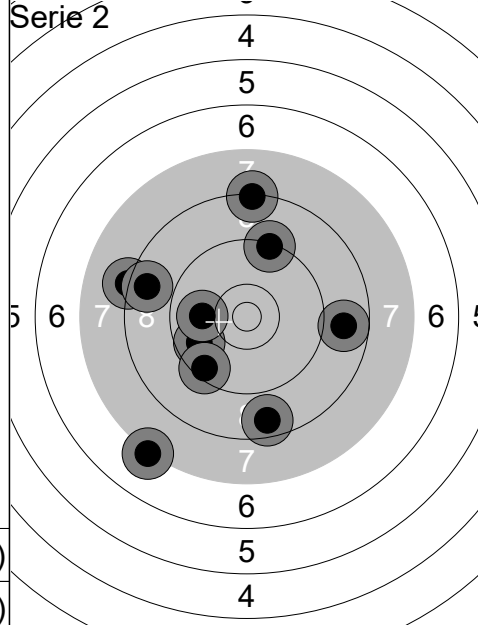

1:	9.7	↖
2:	7.2	↘
3:	9.3	↗
4:	8.6	↘
5:	8.3	↑
6:	9.5	↘
7:	8.2	↖
8:	8.8	→
9:	8.6	↖
10:	9.9	↖
Series		83 (0x)
		171 (0x)

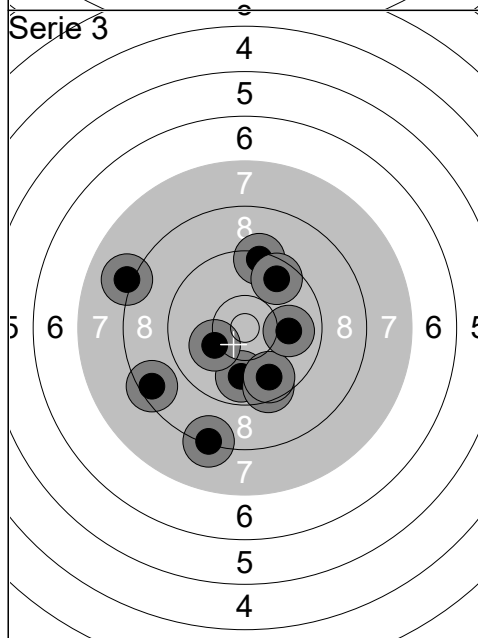

1:	9.9	↘
2:	9.4	↗
3:	9.5	↘
4:	9.7	↘
5:	10.0	→
6:	8.3	↘
7:	9.6	↗
8:	8.1	↖
9:	10.2	↖
10:	8.5	↖
Series		89 (0x)
		260 (0x)

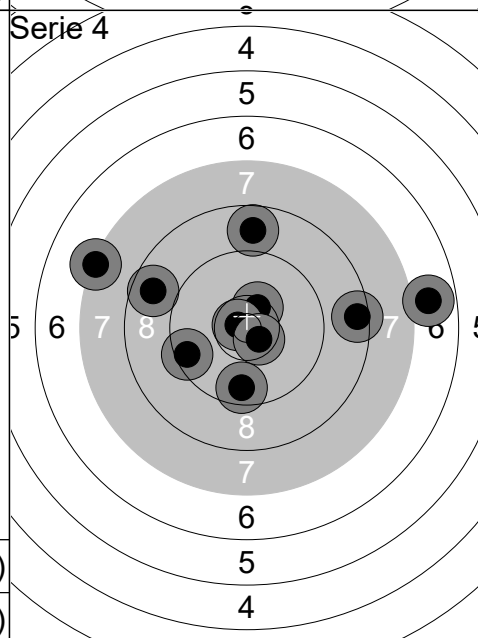

1:	10.4x	↗
2:	7.3	↖
3:	10.7x	↖
4:	8.8	↑
5:	10.6x	↘
6:	8.5	→
7:	9.6	↘
8:	9.5	↖
9:	6.9	→
10:	8.7	↖
Series		85 (3x)
		345 (3x)

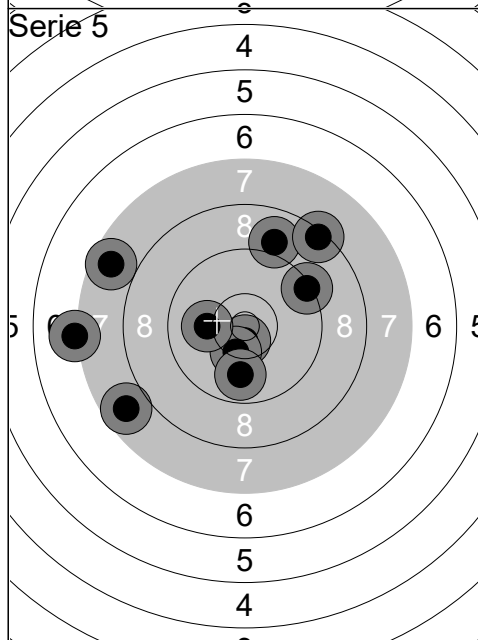

1:	9.0	↗
2:	10.6x	↘
3:	8.4	↗
4:	7.7	↖
5:	10.3	↘
6:	10.1	↖
7:	7.6	↖
8:	9.3	↗
9:	9.9	↘
10:	7.1	↖
Series		86 (1x)
		431 (4x)

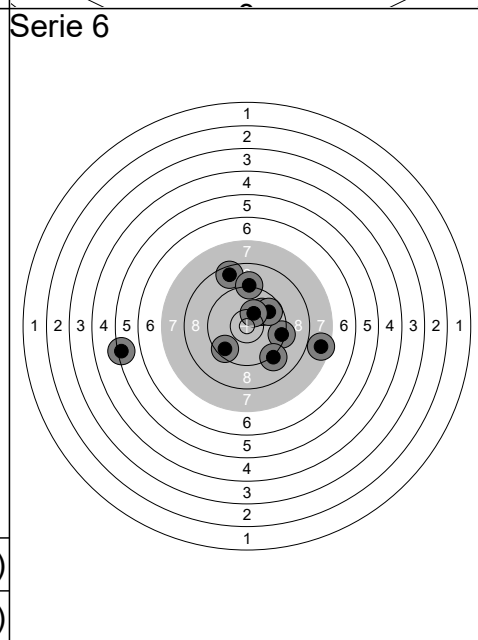

1:	9.4	→
2:	10.1	↗
3:	9.8	↗
4:	8.6	↑
5:	9.2	↑
6:	9.1	↘
7:	7.6	→
8:	10.3	↗
9:	9.6	↘
10:	5.4	↖
Series		85 (0x)
		516 (4x)

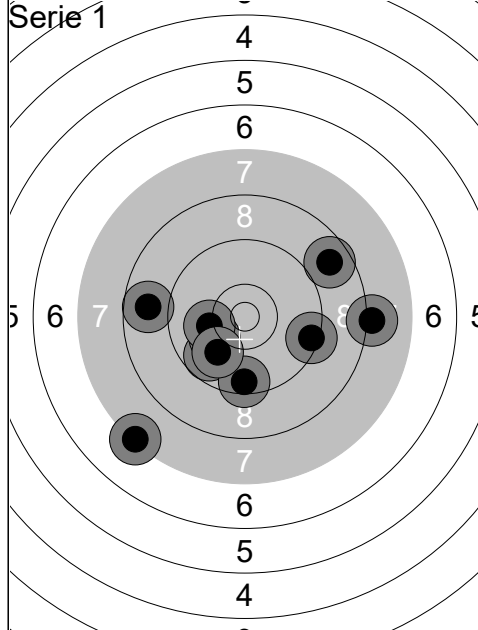

1:	9.4	⇒
2:	8.1	→
3:	9.8	↙
4:	10.1	↙
5:	8.8	←
6:	8.7	↗
7:	10.1	←
8:	7.3	↙
9:	9.5	↓
10:	9.9	↙
Series		87 (0x)
		87 (0x)

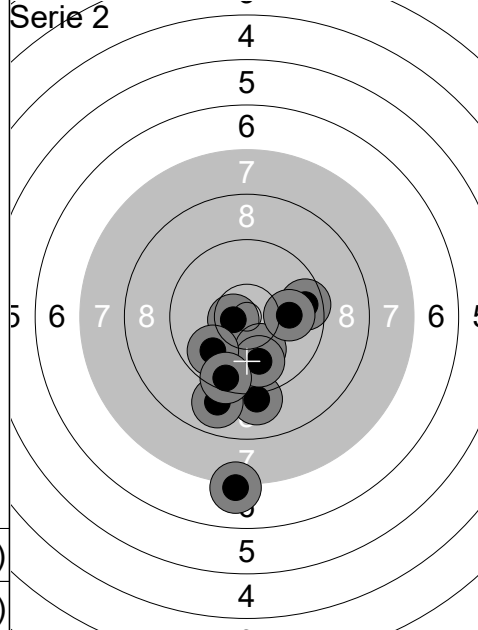

1:	9.1	↓
2:	10.6x	←
3:	10.2	↙
4:	8.9	↙
5:	7.1	↓
6:	9.6	→
7:	9.9	↓
8:	10.0	→
9:	9.9	↙
10:	9.5	↙
Series		90 (1x)
		177 (1x)

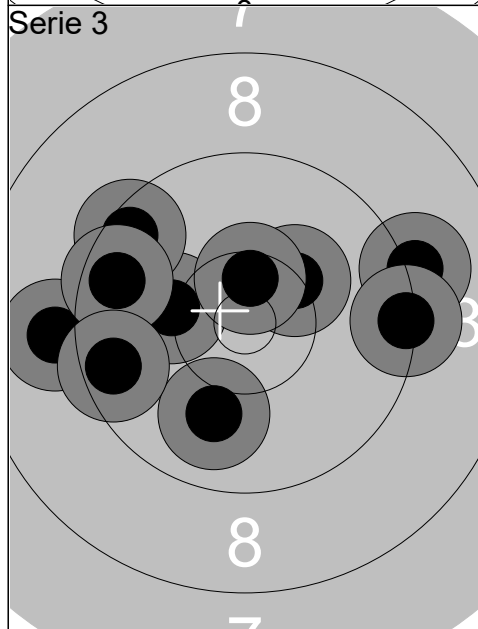

1:	10.2	←
2:	9.5	↖
3:	10.3	↗
4:	9.0	←
5:	9.1	→
6:	10.5x	↑
7:	10.0	↓
8:	9.6	←
9:	9.3	→
10:	9.5	←
Series		94 (1x)
		271 (2x)

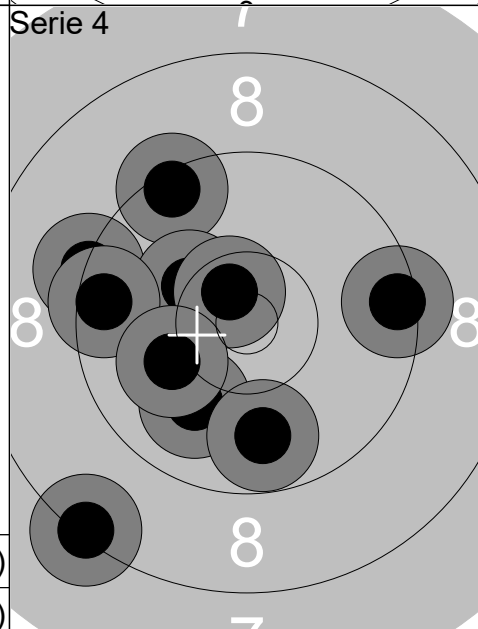

1:	9.4	↗
2:	9.3	←
3:	8.3	↙
4:	9.4	→
5:	10.0	↙
6:	10.3	↖
7:	10.6x	↗
8:	9.5	←
9:	9.8	↓
10:	10.1	←
Series		93 (1x)
		364 (3x)

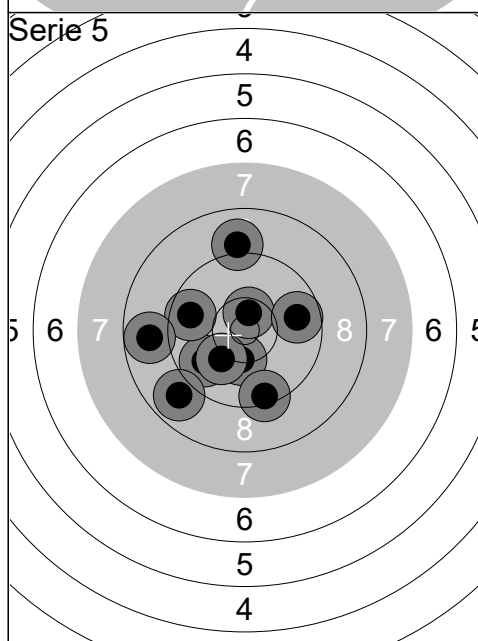

1:	9.8	↙
2:	10.3	↓
3:	9.0	↑
4:	9.4	↙
5:	10.1	↙
6:	8.9	↙
7:	9.7	←
8:	8.8	←
9:	10.5x	↑
10:	9.7	→
Series		91 (1x)
		455 (4x)

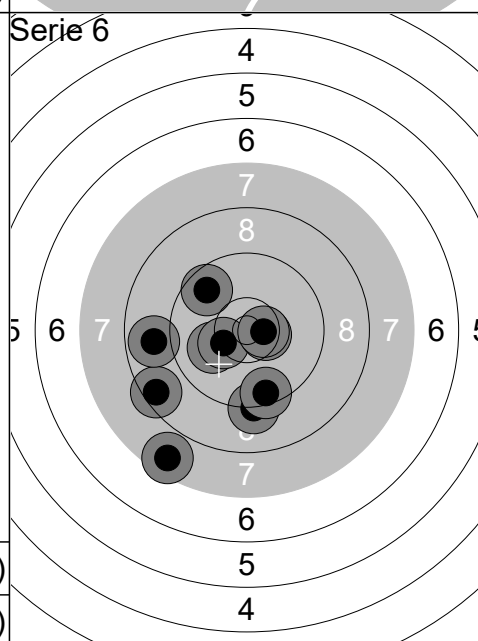

1:	9.7	↖
2:	9.2	↓
3:	10.1	←
4:	8.5	↙
5:	9.5	↓
6:	10.3	←
7:	7.6	↙
8:	10.5x	→
9:	10.6x	→
10:	8.9	←
Series		90 (2x)
		545 (6x)

Relay	Lane	Eduardo Hansen		
4	11	Gundsøllille Megalink OPE	Greve Skytteforening Mp	
18.01.2020	GMO2020 Day 2	Gundsøllille OPEN 2020		
Serie 1		1: 7.8 ↘	Serie 2	1: 9.8 ←
		2: 10.0 ↖		2: 9.5 ↖
		3: 8.7 ↗		3: 7.4 ↗
		4: 9.7 ←		4: 10.2 ↘
		5: 8.9 ↗		5: 10.1 →
		6: 7.0 ↘		6: 10.0 ↘
		7: 9.9 →		7: 9.8 ←
		8: 8.0 ←		8: 8.6 ↗
		9: 9.6 ←		9: 9.6 ↘
		10: 8.7 ↑		10: 9.5 ←
		Series 83 (0x)		Series 90 (0x)
		83 (0x)		173 (0x)
Serie 3		1: 9.3 ↘	Serie 4	1: 9.9 ↑
		2: 10.1 ↑		2: 8.4 ↗
		3: 8.9 ↑		3: 9.0 ↘
		4: 10.0 ←		4: 7.2 ↑
		5: 10.1 ↑		5: 10.4x ↖
		6: 7.4 ↗		6: 9.1 ↑
		7: 9.2 ↘		7: 10.7x ↗
		8: 8.4 ↑		8: 9.3 ←
		9: 9.0 →		9: 9.3 ↖
		10: 9.1 ↖		10: 7.9 ↑
		Series 89 (0x)		Series 87 (2x)
		262 (0x)		349 (2x)
Serie 5		1: 8.0 ↑	Serie 6	1: 9.1 ↘
		2: 7.9 ↑		2: 9.6 ↘
		3: 8.1 ↘		3: 8.4 ←
		4: 7.2 ↑		4: 7.8 ↑
		5: 9.1 →		5: 9.2 ↗
		6: 9.5 ↑		6: 8.6 ↑
		7: 10.3 ↘		7: 9.7 ↘
		8: 8.9 ←		8: 9.5 ↗
		9: 8.7 ↘		9: 7.6 ←
		10: 9.0 ↑		10: 9.3 ↘
		Series 83 (0x)		Series 84 (0x)
		432 (2x)		516 (2x)

Relay	Lane	Manvendra Prasad	
4	12	India	Mp
18.01.2020	GMO2020 Day 2	Gundsøllille OPEN 2020	
	1: 8.1 ↓		1: 9.0 ↗
	2: 9.7 →		2: 8.1 ↙
	3: 10.7x ↑		3: 9.5 ↑
4: 6.9 ↓	4: 7.6 ↓	5: 8.4 ↗	5: 8.4 ↗
5: 8.3 ↗	6: 8.0 ↓	6: 8.0 ↓	6: 8.0 ↓
6: 10.0 ←	7: 9.2 ↘	7: 9.2 ↘	7: 9.2 ↘
7: 9.3 ←	8: 9.0 →	8: 9.0 →	8: 9.0 →
8: 10.3 →	9: 7.3 ↓	9: 7.3 ↓	9: 7.3 ↓
9: 9.9 ←	10: 9.2 ←	10: 9.2 ←	10: 9.2 ←
10: 8.3 ↑			
Series 87 (1x)	Series 83 (0x)		
87 (1x)	170 (1x)		
	1: 9.4 ↓		1: 7.8 →
	2: 10.3 ↓		2: 8.6 ↑
	3: 10.1 →		3: 10.6x ↘
4: 7.2 ↗	4: 9.2 ↘	5: 8.9 ↗	5: 8.9 ↗
5: 9.1 →	6: 9.6 ↓	6: 9.6 ↓	6: 9.6 ↓
6: 10.5x ←	7: 10.3 ↗	7: 10.3 ↗	7: 10.3 ↗
7: 9.1 ↗	8: 7.9 →	8: 7.9 →	8: 7.9 →
8: 8.4 →	9: 9.6 ↗	9: 9.6 ↗	9: 9.6 ↗
9: 9.5 →	10: 9.9 ↙	10: 9.9 ↙	10: 9.9 ↙
10: 8.1 ↑			
Series 89 (1x)	Series 86 (1x)		
259 (2x)	345 (3x)		
	1: 10.1 ↑		1: 9.4 →
	2: 9.3 ↗		2: 9.4 ↗
	3: 9.7 ↑		3: 9.2 ←
4: 9.6 ↓	4: 9.7 →	5: 10.0 ↓	5: 10.0 ↓
5: 9.8 ↑	6: 10.3 ↓	6: 10.3 ↓	6: 10.3 ↓
6: 8.9 ←	7: 9.6 →	7: 9.6 →	7: 9.6 →
7: 9.1 →	8: 9.5 ↑	8: 9.5 ↑	8: 9.5 ↑
8: 9.9 ↗	9: 10.1 ↗	9: 10.1 ↗	9: 10.1 ↗
9: 10.0 ←	10: 10.0 ↓	10: 10.0 ↓	10: 10.0 ↓
10: 9.5 ←			
Series 91 (0x)	Series 94 (0x)		
436 (3x)	530 (3x)		

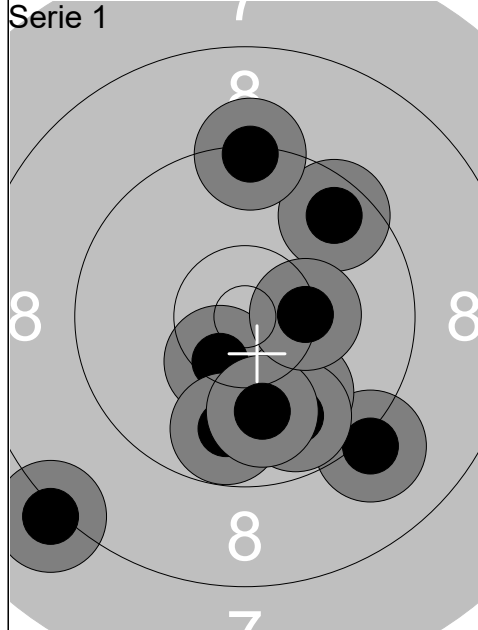

1:	9.6	↗
2:	9.1	↘
3:	8.1	↙
4:	10.4x	↘
5:	10.0	↘
6:	9.8	↘
7:	9.8	↘
8:	9.3	↑
9:	10.0	↘
10:	10.3	→
Series	93 (1x)	
	93 (1x)	

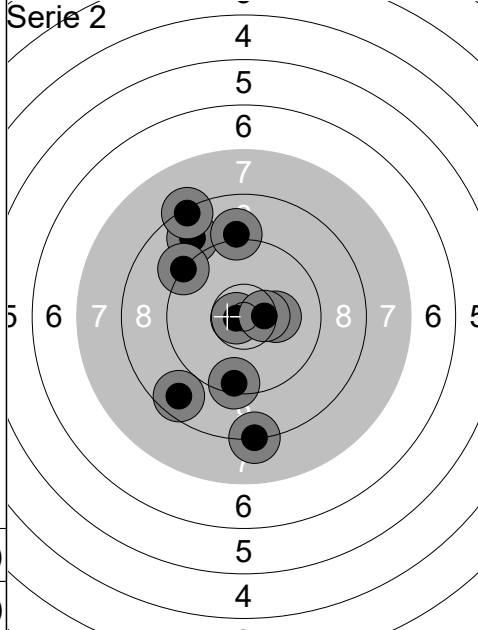

1:	8.2	↘
2:	8.9	↗
3:	9.4	↘
4:	10.2	→
5:	8.6	↘
6:	9.1	↑
7:	9.2	↗
8:	10.8x	←
9:	10.5x	→
10:	8.3	↗
Series	89 (2x)	
	182 (3x)	

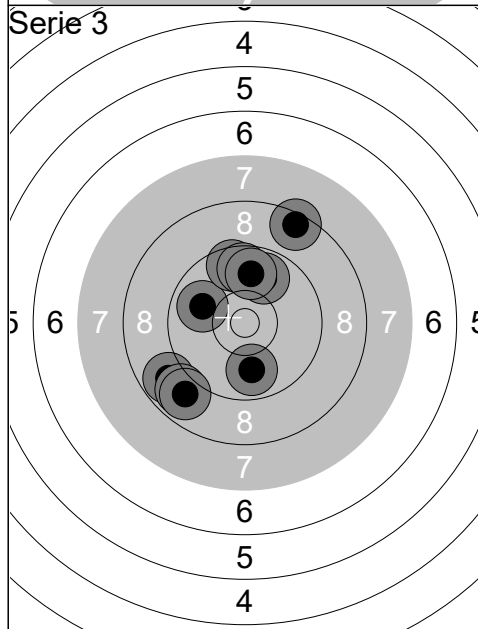

1:	9.9	←
2:	8.5	↗
3:	8.8	↙
4:	9.9	↘
5:	8.9	↙
6:	9.9	↗
7:	9.6	↑
8:	8.9	↙
9:	9.7	↑
10:	9.8	↑
Series	86 (0x)	
	268 (3x)	

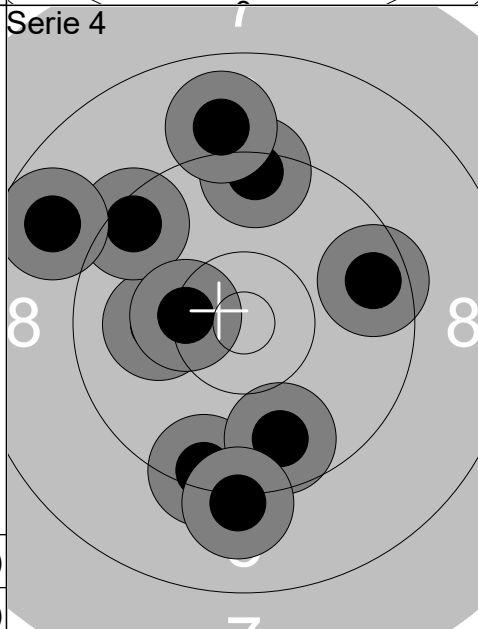

1:	9.4	↘
2:	10.1	←
3:	9.7	↘
4:	9.4	↑
5:	9.1	↘
6:	9.4	↗
7:	9.6	→
8:	8.8	↙
9:	10.4	←
10:	9.0	↑
Series	91 (0x)	
	359 (3x)	

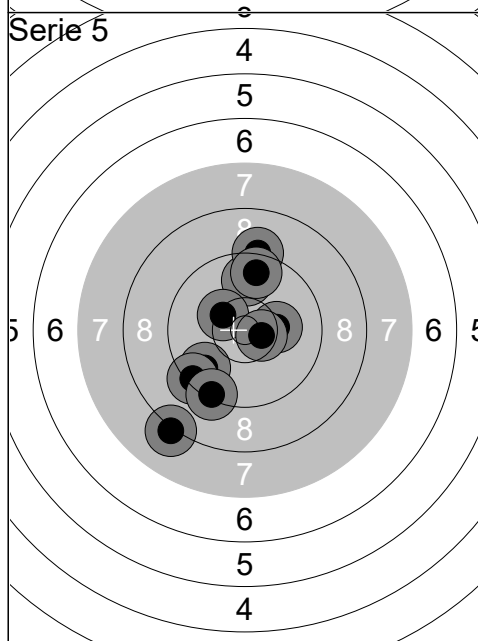

1:	10.2	→
2:	9.8	↑
3:	8.2	↘
4:	9.2	↑
5:	9.7	↙
6:	9.4	↙
7:	10.4	↙
8:	10.5x	→
9:	9.3	↘
10:	9.6	↑
Series	92 (1x)	
	451 (4x)	

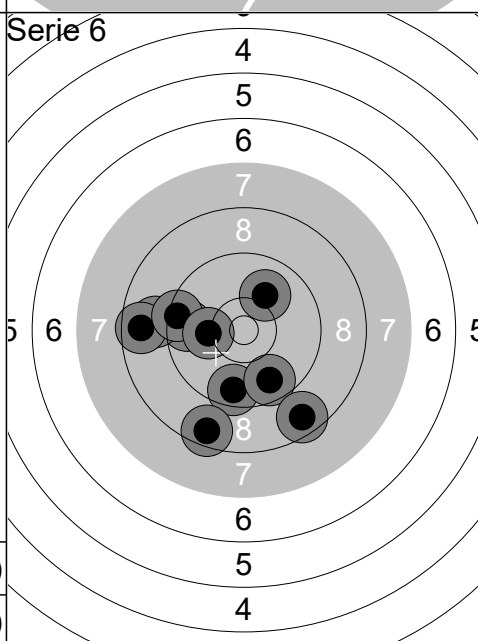

1:	9.6	↘
2:	9.7	←
3:	9.0	←
4:	8.7	←
5:	9.7	↘
6:	8.6	↘
7:	9.4	←
8:	8.6	↘
9:	10.2	←
10:	10.0	↗
Series	89 (0x)	
	540 (4x)	

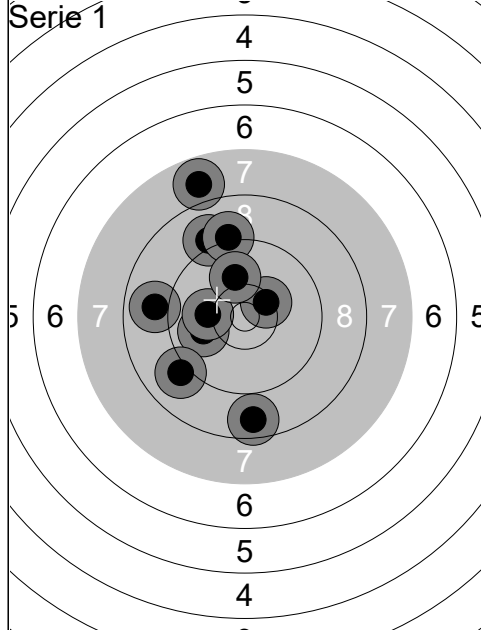

1:	10.0	←
2:	9.1	↗
3:	9.1	↗
4:	7.8	↗
5:	8.9	←
6:	10.4x	↗
7:	8.6	↓
8:	10.1	←
9:	10.0	↑
10:	9.0	↙
Series		90 (1x)
		90 (1x)

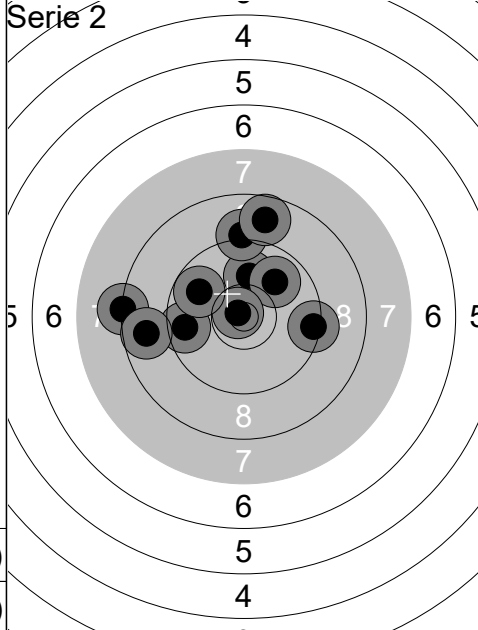

1:	9.6	←
2:	10.0	↑
3:	8.2	←
4:	9.4	→
5:	9.1	↑
6:	9.9	↗
7:	10.8x	↖
8:	8.7	↑
9:	8.8	←
10:	9.8	↖
Series		89 (1x)
		179 (2x)

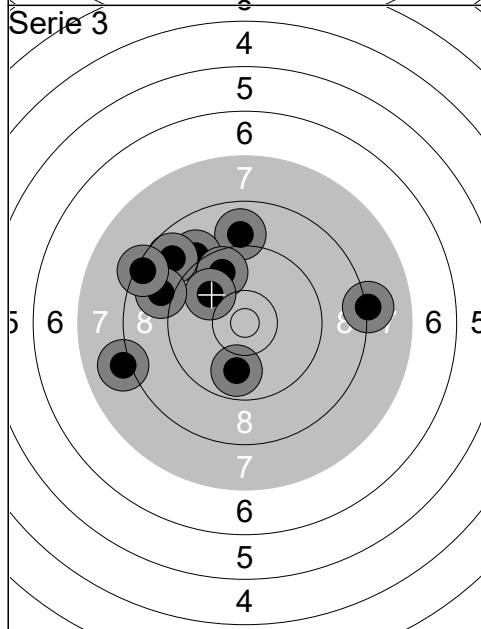

1:	9.0	↑
2:	9.1	↗
3:	9.7	↗
4:	9.9	↓
5:	8.2	→
6:	9.9	↗
7:	8.1	←
8:	8.8	↗
9:	9.0	←
10:	8.4	↖
Series		86 (0x)
		265 (2x)

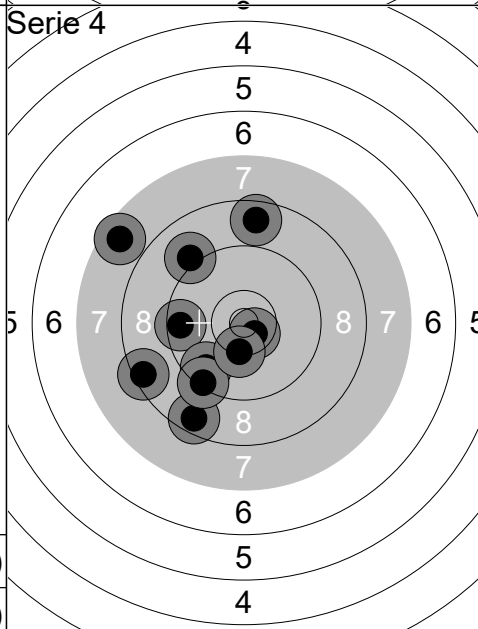

1:	9.5	←
2:	8.6	↓
3:	10.6x	↘
4:	9.6	↓
5:	7.6	↖
6:	8.4	↖
7:	9.1	↖
8:	8.6	↑
9:	9.3	↓
10:	10.3	↓
Series		87 (1x)
		352 (3x)

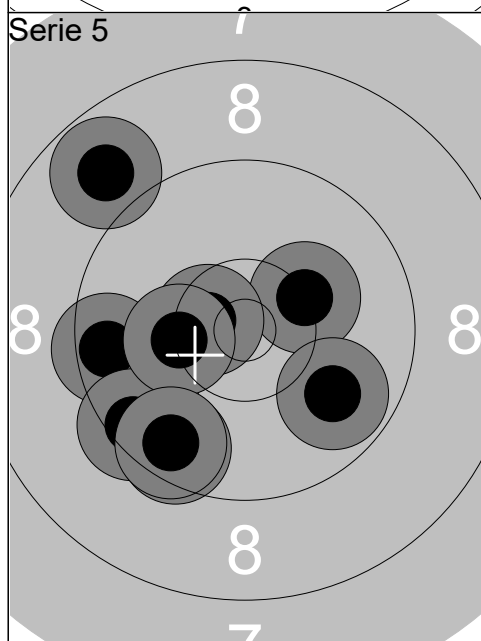

1:	9.8	←
2:	9.5	←
3:	8.8	↗
4:	9.5	↙
5:	10.3	↗
6:	10.6x	↖
7:	9.6	↓
8:	9.9	↘
9:	10.3	←
10:	9.6	↙
Series		92 (1x)
		444 (4x)

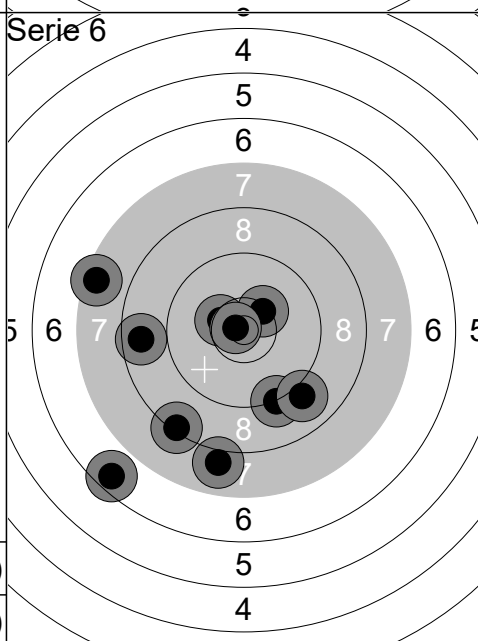

1:	8.3	↙
2:	10.4x	↖
3:	8.0	↓
4:	9.2	↓
5:	7.5	←
6:	8.6	←
7:	10.4	↗
8:	9.0	↘
9:	10.7x	↖
10:	6.6	↙
Series		85 (2x)
		529 (6x)

Relay	Lane	Jonas Kofoed Hansen	
4	16	Gundsøllille Megalink OPE	Vejle Skytteforening
18.01.2020		GMO2020 Day 2	Gundsøllille OPEN 2020
Serie 1		1: 9.6 ↙ 2: 9.4 ↙ 3: 10.4x → 4: 10.1 ↓ 5: 10.6x → 6: 10.4x ↑ 7: 10.4x ↓ 8: 9.8 ↖ 9: 10.4x ↗ 10: 10.0 ← Series 97 (5x) 97 (5x)	Serie 2 1: 10.7x ↑ 2: 10.3 ↙ 3: 10.3 → 4: 10.5x ↖ 5: 9.9 ↗ 6: 10.0 ↑ 7: 9.5 ↑ 8: 9.9 ↓ 9: 10.7x ↑ 10: 9.5 ↗ Series 96 (3x) 193 (8x)
Serie 3		1: 9.7 ↗ 2: 10.4x ↙ 3: 10.6x ↙ 4: 9.9 → 5: 10.0 ← 6: 9.3 ↓ 7: 9.1 → 8: 9.7 ↗ 9: 9.4 ↓ 10: 9.6 ↓ Series 93 (2x) 286 (10x)	Serie 4 1: 10.2 ↓ 2: 10.2 ↓ 3: 10.6x ↙ 4: 9.8 ↙ 5: 9.0 ← 6: 10.3 ↙ 7: 8.7 ↑ 8: 10.1 ↘ 9: 10.6x ↑ 10: 9.3 ↓ Series 95 (2x) 381 (12x)
Serie 5		1: 10.3 ↗ 2: 10.4x ↗ 3: 10.1 ← 4: 10.7x ↖ 5: 10.5x ↖ 6: 10.5x ↖ 7: 10.8x ↓ 8: 9.5 ↓ 9: 9.2 ↓ 10: 10.3 ← Series 98 (5x) 479 (17x)	Serie 6 1: 10.1 ↓ 2: 9.5 ↘ 3: 8.7 ↑ 4: 10.1 ↖ 5: 10.6x ↗ 6: 10.3 ↙ 7: 10.2 ↖ 8: 10.7x ↖ 9: 10.5x ↘ 10: 9.6 ↓ Series 96 (3x) 575 (20x)

Relay	Lane	Participant		Mp
4	17	Marcus Errebo		
Gundsøllille Megalink OPE		Maribo Skytteforening		
18.01.2020		GMO2020 Day 2		Gundsøllille OPEN 2020
Serie 1		1: 9.2 ↗ 2: 10.5x → 3: 9.9 ↓ 4: 10.5x ↑ 5: 10.5x ↗ 6: 10.2 ↓ 7: 10.2 ↖ 8: 9.9 ↖ 9: 10.3 ↖ 10: 10.6x ↓ Series 97 (4x) 97 (4x)	Serie 2 1: 9.2 ↗ 2: 10.6x ↙ 3: 9.5 ↙ 4: 9.7 ↖ 5: 10.6x ↑ 6: 10.6x ↘ 7: 9.9 ↙ 8: 10.3 ↑ 9: 9.7 ↑ 10: 10.2 ↗ Series 95 (3x) 192 (7x)	
Serie 3		1: 10.1 ← 2: 9.8 ↖ 3: 9.8 ↓ 4: 10.1 ↓ 5: 9.8 ↘ 6: 9.9 ← 7: 10.3 ← 8: 10.4x ↓ 9: 9.9 ↑ 10: 9.9 → Series 94 (1x) 286 (8x)	Serie 4 1: 10.5x ↙ 2: 9.1 ↖ 3: 9.5 → 4: 10.0 ← 5: 10.2 → 6: 9.6 ← 7: 9.7 → 8: 10.1 ↓ 9: 10.5x ↗ 10: 10.3 → Series 96 (2x) 382 (10x)	
Serie 5		1: 9.6 ↓ 2: 10.5x ↖ 3: 9.7 ↙ 4: 10.8x ↓ 5: 9.9 ↓ 6: 10.4x ← 7: 10.0 ↑ 8: 10.0 ↓ 9: 10.1 ↑ 10: 10.5x → Series 97 (4x) 479 (14x)	Serie 6 1: 10.1 ↗ 2: 9.9 ↙ 3: 10.3 ↓ 4: 8.6 ↑ 5: 10.2 → 6: 9.8 ↖ 7: 10.0 ← 8: 10.1 ↘ 9: 10.9x ↑ 10: 10.5x ↘ Series 96 (2x) 575 (16x)	

Relay	Lane	Malik Bazara		
4	18	Gundsøllille Megalink OPE	Helsingør Salonskytte Forening Mp	
18.01.2020	GMO2020 Day 2	Gundsøllille OPEN 2020		
Serie 1		1: 9.4 ←	Serie 2	1: 9.6 ↗
		2: 9.7 ↘		2: 9.1 ↑
		3: 8.9 ↗		3: 10.2 ↘
		4: 6.5 →		4: 10.3 ↓
		5: 9.7 →		5: 9.0 ↓
		6: 9.3 ↘		6: 10.2 ↓
		7: 8.1 ←		7: 10.3 ←
		8: 9.8 ↓		8: 9.2 ←
		9: 9.9 ↓		9: 7.7 ←
		10: 8.9 →		10: 9.2 ↓
		Series 84 (0x)		Series 92 (0x)
		84 (0x)		176 (0x)
Serie 3		1: 8.8 ←	Serie 4	1: 6.2 ←
		2: 10.0 ↓		2: 10.1 ↑
		3: 8.8 ↓		3: 9.5 →
		4: 9.4 →		4: 9.2 ↘
		5: 10.9x ←		5: 9.6 ↓
		6: 8.6 →		6: 9.0 ↑
		7: 9.0 ↓		7: 9.6 ↑
		8: 8.0 ↘		8: 9.9 ↓
		9: 8.6 ↑		9: 10.1 ↘
		10: 10.8x ↗		10: 9.3 ↑
		Series 88 (2x)		Series 89 (0x)
		264 (2x)		353 (2x)
Serie 5		1: 9.1 ↓	Serie 6	1: 9.0 ↗
		2: 9.8 ←		2: 9.8 ↗
		3: 10.7x ↘		3: 9.8 →
		4: 10.2 ←		4: 8.6 ↑
		5: 7.8 ↑		5: 8.1 ↗
		6: 10.3 ↓		6: 8.9 →
		7: 9.3 →		7: 9.6 ↑
		8: 9.9 ↓		8: 10.1 ↗
		9: 9.3 ←		9: 9.9 ↗
		10: 10.1 ↓		10: 9.9 ←
		Series 92 (1x)		Series 88 (0x)
		445 (3x)		533 (3x)